

Technical Information

Proline Promag P 100

Electromagnetic flowmeter



The flowmeter for highest medium temperatures with an ultra-compact transmitter

Application

- The bidirectional measuring principle is virtually independent of pressure, density, temperature and viscosity
- Dedicated to chemical and process applications with corrosive liquids

Device properties

- Nominal diameter: max. DN 600 (24")
- All common Ex approvals
- Liner made of PTFE or PFA
- Robust, ultra-compact transmitter housing
- Local display available

Your benefits

- Versatile range of applications – wide variety of wetted materials
- Maintenance-free – no moving parts
- Space-saving transmitter – full functionality on smallest footprint
- Time-saving local operation without additional software and hardware – integrated web server
- Integrated verification – Heartbeat Technology





Table of contents

About this document	3	Process	40
Symbols	3	Medium temperature range	40
Function and system design	4	Conductivity	40
Measuring principle	4	Flow limit	40
Measuring system	5	Pressure loss	40
Equipment architecture	6	System pressure	40
Reliability	6	Vibrations	40
Input	6	Magnetism and static electricity	40
Measured variable	6	Mechanical construction	40
Measuring range	6	Dimensions in SI units	40
Operable flow range	8	Dimensions in US units	43
Input signal	8	Weight	45
Output	8	Measuring tube specification	46
Output signal	8	Materials	47
Signal on alarm	10	Fitted electrodes	48
Low flow cut off	11	Process connections	48
Protocol-specific data	12	Surface roughness	49
Power supply	19	Operability	49
Terminal assignment	19	Operating concept	49
Pin assignment, device plug	25	Local display	49
Supply voltage	28	Remote operation	49
Power consumption	28	Service interface	52
Current consumption	28	Certificates and approvals	54
Device fuse	28	CE mark	54
Power supply failure	28	UKCA marking	54
Electrical connection	29	RCM marking	54
Potential equalization	30	Ex approval	54
Terminals	31	HART certification	55
Cable entries	31	Certification PROFIBUS	55
Cable specification	31	EtherNet/IP certification	55
Performance characteristics	32	Certification PROFINET	55
Reference operating conditions	32	Pressure Equipment Directive	55
Maximum measurement error	32	External standards and guidelines	56
Repeatability	32	Ordering information	56
Temperature measurement response time	32	Application packages	57
Influence of ambient temperature	33	Cleaning	57
Mounting	33	Heartbeat Technology	57
Mounting location	33	Accessories	57
Orientation	36	Device-specific accessories	57
Inlet and outlet runs	37	Communication-specific accessories	58
Adapters	38	Service-specific accessories	58
Environment	38	System components	59
Ambient temperature range	38	Documentation	59
Storage temperature	39	Standard documentation	59
Degree of protection	39	Supplementary device-dependent documentation	59
Vibration-resistance and shock resistance	39	Registered trademarks	60
Mechanical load	39		
Electromagnetic compatibility (EMC)	39		









About this document

Symbols





Electrical symbols

Symbol	Meaning
	Direct current
	Alternating current
	Direct current and alternating current
	Ground connection A grounded terminal which, as far as the operator is concerned, is grounded via a grounding system.
	Potential equalization connection (PE: protective earth) Ground terminals that must be connected to ground prior to establishing any other connections. The ground terminals are located on the interior and exterior of the device: <ul style="list-style-type: none"> ■ Interior ground terminal: potential equalization is connected to the supply network. ■ Exterior ground terminal: device is connected to the plant grounding system.

Symbols for certain types of information

Symbol	Meaning
	Permitted Procedures, processes or actions that are permitted.
	Preferred Procedures, processes or actions that are preferred.
	Forbidden Procedures, processes or actions that are forbidden.
	Tip Indicates additional information.
	Reference to documentation
	Reference to page
	Reference to graphic
	Visual inspection

Symbols in graphics

Symbol	Meaning
1, 2, 3, ...	Item numbers
	Series of steps
A, B, C, ...	Views
A-A, B-B, C-C, ...	Sections
	Hazardous area
	Safe area (non-hazardous area)
	Flow direction

Function and system design

Measuring principle

Following *Faraday's law of magnetic induction*, a voltage is induced in a conductor moving through a magnetic field.

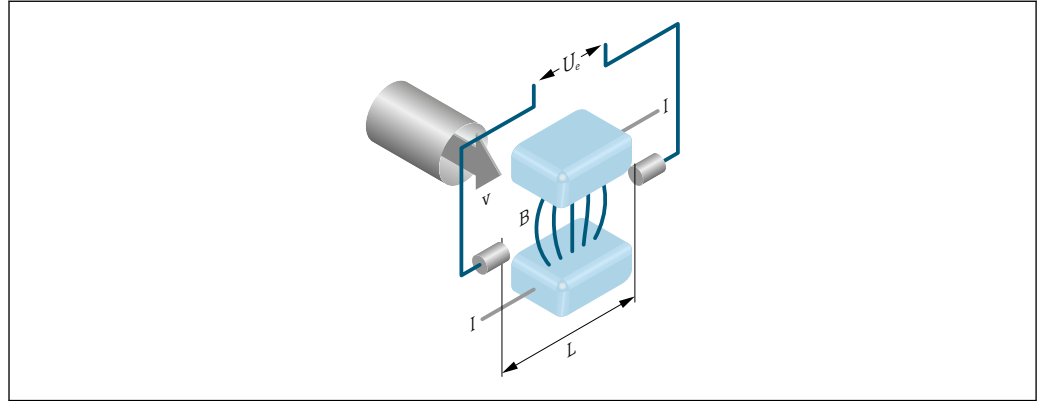

U_e Induced voltage
 B Magnetic induction (magnetic field)
 L Electrode spacing
 I Current
 v Flow velocity

In the electromagnetic measuring principle, the flowing medium is the moving conductor. The voltage induced (U_e) is proportional to the flow velocity (v) and is supplied to the amplifier by means of two measuring electrodes. The flow volume (Q) is calculated via the pipe cross-section (A). The magnetic field is created through a switched direct current of alternating polarity.

Formulae for calculation

- Induced voltage $U_e = B \cdot L \cdot v$
- Volume flow $Q = A \cdot v$

Measuring system

The device consists of a transmitter and a sensor.
 The device is available as a compact version:
 The transmitter and sensor form a mechanical unit.

Transmitter

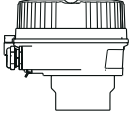
<p>Proline 100</p>  <p style="text-align: right; font-size: small;">A0016693</p>	<p>Device versions and materials: Compact, aluminum, coated: Aluminum, AlSi10Mg, coated</p> <p>Configuration:</p> <ul style="list-style-type: none"> ▪ Via operating tools (e.g. FieldCare, DeviceCare) ▪ Also for device version with 4-20 mA HART, pulse/frequency/switch output: <ul style="list-style-type: none"> ▪ Via web browser (e.g. Microsoft Internet Explorer) ▪ Also for device version with EtherNet/IP output: <ul style="list-style-type: none"> ▪ Via web browser (e.g. Microsoft Internet Explorer) ▪ Via Add-on Profile Level 3 for automation system from Rockwell Automation ▪ Via Electronic Data Sheet (EDS) ▪ Also for device version with PROFINET output: <ul style="list-style-type: none"> ▪ Via web browser (e.g. Microsoft Internet Explorer) ▪ Via device master file (GSD)
--	--

Sensor

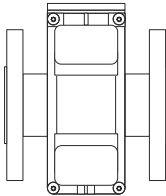
<p>Promag P</p>  <p style="text-align: right; font-size: small;">A0017703</p>	<p>Nominal diameter range: DN 15 to 600 (½ to 24")</p> <p>Materials:</p> <ul style="list-style-type: none"> ▪ Sensor housing: <ul style="list-style-type: none"> ▪ Aluminum, AlSi10Mg, coated ▪ DN 15 to 300 (½ to 12"): aluminum, AlSi10Mg, coated ▪ DN 350 to 600 (14 to 24"): carbon steel with protective varnish ▪ Measuring tubes ¹⁾: stainless steel, 1.4301/1.4306 ▪ Liner: PFA, PTFE ▪ Electrodes: stainless steel, 1.4435 (F316L); Alloy C22, 2.4602 (UNS N06022); platinum; tantalum; titanium ▪ Process connections: stainless steel, 1.4404 ²⁾/1.4571/F316L ²⁾; carbon steel, A105/E250C ²⁾/S235JRG2/S275JR ▪ Seals: as per DIN EN 1514-1 ▪ Ground disks: stainless steel, 1.4435 (316L); Alloy C22, 2.4602 (UNS N06022); tantalum; titanium
---	--

- 1) For flanges made of carbon steel with Al/Zn protective coating (DN 15 to 300 (½ to 12")) or protective varnish (DN 350 to 600 (14 to 24"))
- 2) With Al/Zn protective coating (DN 15 to 300 (½ to 12")) or protective varnish (DN 350 to 600 (14 to 24"))

Equipment architecture

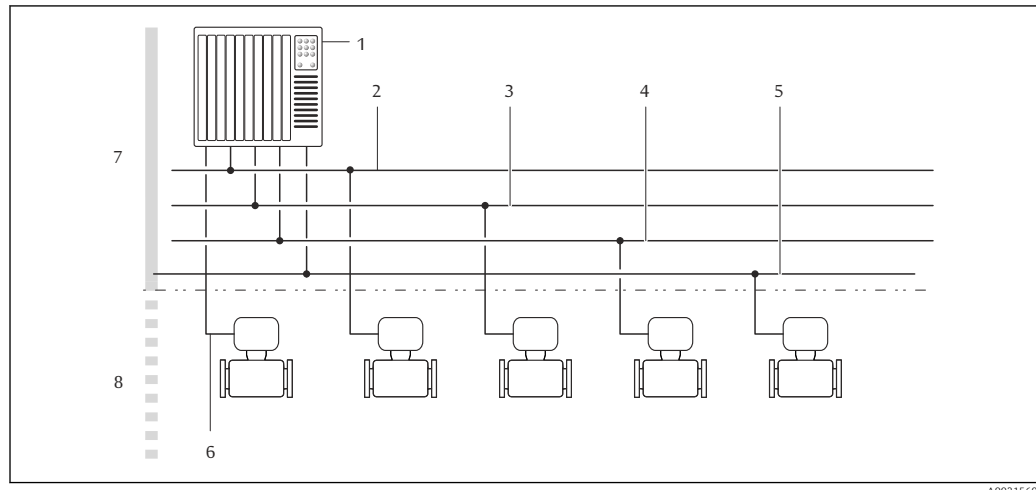

1 Possibilities for integrating measuring instruments into a system

- 1 Automation system (e.g. PLC)
- 2 EtherNet/IP
- 3 PROFIBUS DP
- 4 PROFINET
- 5 Modbus RS485
- 6 4-20 mA HART, pulse/frequency/switch output
- 7 Non-hazardous area
- 8 Non-hazardous area and Zone 2/Div. 2

Reliability

IT security

The manufacturer warranty is valid only if the product is installed and used as described in the Operating Instructions. The product is equipped with security mechanisms to protect it against any inadvertent changes to the settings.

IT security measures, which provide additional protection for the product and associated data transfer, must be implemented by the operators themselves in line with their security standards.

Input

Measured variable

Direct measured variables

- Volume flow (proportional to induced voltage)
- Electrical conductivity

Calculated measured variables

- Mass flow
- Corrected volume flow

Measuring range

Typically $v = 0.01$ to 10 m/s (0.03 to 33 ft/s) with the specified accuracy

Electrical conductivity: ≥ 5 $\mu\text{S}/\text{cm}$ for liquids in general

Flow characteristic values in SI units

Nominal diameter		Recommended Flow rate min./max. full scale value ($v \sim 0.3/10$ m/s) [dm ³ /min]	Factory settings		
[mm]	[in]		Current output full scale value ¹⁾ ($v \sim 2.5$ m/s) [dm ³ /min]	Pulse value ¹⁾ (~ 2 pulse/s) [dm ³]	Low flow cut off ($v \sim 0.04$ m/s) [dm ³ /min]
15	½	4 to 100	25	0.2	0.5
25	1	9 to 300	75	0.5	1

Nominal diameter		Recommended Flow rate min./max. full scale value (v ~ 0.3/10 m/s)	Factory settings		
[mm]	[in]		Current output full scale value ¹⁾ (v ~ 2.5 m/s)	Pulse value ¹⁾ (~ 2 pulse/s)	Low flow cut off (v ~ 0.04 m/s)
		[dm ³ /min]	[dm ³ /min]	[dm ³]	[dm ³ /min]
32	–	15 to 500	125	1	2
40	1 ½	25 to 700	200	1.5	3
50	2	35 to 1 100	300	2.5	5
65	–	60 to 2 000	500	5	8
80	3	90 to 3 000	750	5	12
100	4	145 to 4 700	1200	10	20
125	–	220 to 7 500	1850	15	30
150	6	20 to 600 m ³ /h	150 m ³ /h	0.03 m ³	2.5 m ³ /h
200	8	35 to 1 100 m ³ /h	300 m ³ /h	0.05 m ³	5 m ³ /h
250	10	55 to 1 700 m ³ /h	500 m ³ /h	0.05 m ³	7.5 m ³ /h
300	12	80 to 2 400 m ³ /h	750 m ³ /h	0.1 m ³	10 m ³ /h
350	14	110 to 3 300 m ³ /h	1 000 m ³ /h	0.1 m ³	15 m ³ /h
400	16	140 to 4 200 m ³ /h	1 200 m ³ /h	0.15 m ³	20 m ³ /h
450	18	180 to 5 400 m ³ /h	1 500 m ³ /h	0.25 m ³	25 m ³ /h
500	20	220 to 6 600 m ³ /h	2 000 m ³ /h	0.25 m ³	30 m ³ /h
600	24	310 to 9 600 m ³ /h	2 500 m ³ /h	0.3 m ³	40 m ³ /h



1) HART only

Flow characteristic values in US units



Nominal diameter		Recommended Flow rate min./max. full scale value (v ~ 0.3/10 m/s)	Factory settings		
[in]	[mm]		Current output full scale value ¹⁾ (v ~ 2.5 m/s)	Pulse value ¹⁾ (~ 2 pulse/s)	Low flow cut off (v ~ 0.04 m/s)
		[gal/min]	[gal/min]	[gal]	[gal/min]
½	15	1.0 to 27	6	0.1	0.15
1	25	2.5 to 80	18	0.2	0.25
1 ½	40	7 to 190	50	0.5	0.75
2	50	10 to 300	75	0.5	1.25
3	80	24 to 800	200	2	2.5
4	100	40 to 1 250	300	2	4
6	150	90 to 2 650	600	5	12
8	200	155 to 4 850	1200	10	15
10	250	250 to 7 500	1500	15	30
12	300	350 to 10 600	2400	25	45
14	350	500 to 15 000	3600	30	60
16	400	600 to 19 000	4800	50	60
18	450	800 to 24 000	6000	50	90

Nominal diameter		Recommended Flow rate min./max. full scale value (v ~ 0.3/10 m/s)	Factory settings		
			Current output full scale value ¹⁾ (v ~ 2.5 m/s)	Pulse value ¹⁾ (~ 2 pulse/s)	Low flow cut off (v ~ 0.04 m/s)
[in]	[mm]	[gal/min]	[gal/min]	[gal]	[gal/min]
20	500	1 000 to 30 000	7500	75	120
24	600	1 400 to 44 000	10500	100	180

1) HART only

 To calculate the measuring range, use the *Applicator* sizing tool →  58

Recommended measuring range

 Flow limit →  40

Operable flow range



Over 1000 : 1

Input signal

External measured values

To increase the measurement accuracy of certain measured variables or to calculate the corrected volume flow, the automation system can continuously write different measured values to the measuring instrument:

- Operating pressure to increase measurement accuracy (Endress+Hauser recommends the use of a pressure measuring instrument for absolute pressure, e.g. Cerabar M or Cerabar S)
- Medium temperature to increase measurement accuracy (e.g. iTEMP)
- Reference density for calculating the corrected volume flow

 Various pressure transmitters and temperature measuring instruments can be ordered from Endress+Hauser: see "Accessories" section →  59

It is recommended to read in external measured values to calculate the following measured variables:
Corrected volume flow

HART protocol

The measured values are written from the automation system to the measuring device via the HART protocol. The pressure transmitter must support the following protocol-specific functions:

- HART protocol
- Burst mode

Digital communication

The measured values can be written by the automation system via:

- PROFIBUS DP
- Modbus RS485
- EtherNet/IP
- PROFINET

Output

Output signal

HART current output

Current output	4-20 mA HART (active)
Maximum output values	<ul style="list-style-type: none"> ▪ DC 24 V (no flow) ▪ 22.5 mA
Load	0 to 700 Ω

Resolution	0.38 µA
Damping	Configurable: 0.07 to 999 s
Assignable measured variables	<ul style="list-style-type: none"> ▪ Volume flow ▪ Mass flow ▪ Corrected volume flow ▪ Flow velocity ▪ Conductivity ▪ Electronic temperature

Pulse/frequency/switch output

Function	Can be set to pulse, frequency or switch output
Version	Passive, open collector
Maximum input values	<ul style="list-style-type: none"> ▪ DC 30 V ▪ 25 mA
Voltage drop	For 25 mA: ≤ DC 2 V
Pulse output	
Pulse width	Configurable: 0.05 to 2 000 ms
Maximum pulse rate	10 000 Impulse/s
Pulse value	Adjustable
Assignable measured variables	<ul style="list-style-type: none"> ▪ Volume flow ▪ Mass flow ▪ Corrected volume flow
Frequency output	
Output frequency	Configurable: 0 to 10 000 Hz
Damping	Configurable: 0 to 999 s
Pulse/pause ratio	1:1
Assignable measured variables	<ul style="list-style-type: none"> ▪ Volume flow ▪ Mass flow ▪ Corrected volume flow ▪ Flow velocity ▪ Conductivity ▪ Electronic temperature
Switch output	
Switching behavior	Binary, conductive or non-conductive
Switching delay	Configurable: 0 to 100 s
Number of switching cycles	Unlimited
Assignable functions	<ul style="list-style-type: none"> ▪ Off ▪ On ▪ Diagnostic behavior ▪ Limit value: <ul style="list-style-type: none"> ▪ Off ▪ Volume flow ▪ Mass flow ▪ Corrected volume flow ▪ Flow velocity ▪ Conductivity ▪ Totalizer 1-3 ▪ Electronic temperature ▪ Flow direction monitoring ▪ Status <ul style="list-style-type: none"> ▪ Empty pipe detection ▪ Low flow cut off

PROFIBUS DP

Signal encoding	NRZ code
Data transfer	9.6 kBaud...12 MBaud
Terminating resistor	Integrated, can be activated via DIP switches

Modbus RS485

Physical interface	In accordance with EIA/TIA-485-A standard
Terminating resistor	Integrated, can be activated via DIP switch on the transmitter electronics module

EtherNet/IP

Standards	In accordance with IEEE 802.3
-----------	-------------------------------

PROFINET

Standards	In accordance with IEEE 802.3
-----------	-------------------------------

Signal on alarm

Depending on the interface, failure information is displayed as follows:

Current output 4 to 20 mA

4 to 20 mA

Failure mode	Choose from: <ul style="list-style-type: none"> ■ 4 to 20 mA in accordance with NAMUR recommendation NE 43 ■ 4 to 20 mA in accordance with US ■ Min. value: 3.59 mA ■ Max. value: 22.5 mA ■ Definable value between: 3.59 to 22.5 mA ■ Actual value ■ Last valid value
--------------	---

Pulse/frequency/switch output

Pulse output	
Fault mode	Choose from: <ul style="list-style-type: none"> ■ Actual value ■ No pulses
Frequency output	
Fault mode	Choose from: <ul style="list-style-type: none"> ■ Actual value ■ 0 Hz ■ Definable value between: 0 to 12 500 Hz
Switch output	
Fault mode	Choose from: <ul style="list-style-type: none"> ■ Current status ■ Open ■ Closed

PROFIBUS DP

Status and alarm messages	Diagnostics in accordance with PROFIBUS PA Profile 3.02
---------------------------	---

Modbus RS485

Failure mode	Choose from: <ul style="list-style-type: none"> ▪ NaN value instead of current value ▪ Last valid value
---------------------	---

EtherNet/IP

Device diagnostics	Device condition can be read out in Input Assembly
---------------------------	--

PROFINET

Device diagnostics	According to "Application Layer protocol for decentralized periphery", Version 2.3
---------------------------	--

Local display



Plain text display	With information on cause and remedial measures
Backlight	Red backlighting indicates a device error.

 Status signal as per NAMUR recommendation NE 107

Interface/protocol

- Via digital communication:
 - HART protocol
 - PROFIBUS DP
 - Modbus RS485
 - EtherNet/IP
 - PROFINET
- Via service interface
CDI-RJ45 service interface

Plain text display	With information on cause and remedial measures
---------------------------	---

 Additional information on remote operation →  49

Web browser

Plain text display	With information on cause and remedial measures
---------------------------	---

Light emitting diodes (LED)

Status information	Status indicated by various light emitting diodes The following information is displayed depending on the device version: <ul style="list-style-type: none"> ▪ Supply voltage active ▪ Data transmission active ▪ Device alarm/error has occurred ▪ EtherNet/IP network available ▪ EtherNet/IP connection established ▪ PROFINET network available ▪ PROFINET connection established ▪ PROFINET blinking feature
---------------------------	--

Low flow cut off

The switch points for low flow cut off are user-selectable.

Protocol-specific data

HART

Manufacturer ID	0x11
Device type ID	0x3A
HART protocol revision	7
Device description files (DTM, DD)	Information and files under: www.endress.com
HART load	Min. 250 Ω
Dynamic variables	<p>Read out the dynamic variables: HART command 3 The measured variables can be freely assigned to the dynamic variables.</p> <p>Measured variables for PV (primary dynamic variable)</p> <ul style="list-style-type: none"> ▪ Off ▪ Volume flow ▪ Mass flow ▪ Corrected volume flow ▪ Flow velocity ▪ Temperature ▪ Electronic temperature <p>Measured variables for SV, TV, QV (secondary, tertiary and quaternary dynamic variable)</p> <ul style="list-style-type: none"> ▪ Volume flow ▪ Mass flow ▪ Corrected volume flow ▪ Flow velocity ▪ Temperature ▪ Electronic temperature ▪ Totalizer 1 ▪ Totalizer 2 ▪ Totalizer 3
Device variables	<p>Read out the device variables: HART command 9 The device variables are permanently assigned.</p> <p>A maximum of 8 device variables can be transmitted:</p> <ul style="list-style-type: none"> ▪ 0 = volume flow ▪ 1 = mass flow ▪ 2 = corrected volume flow ▪ 3 = flow velocity ▪ 4 = conductivity ▪ 5 = corrected conductivity ▪ 6 = temperature ▪ 7 = electronic temperature ▪ 8 = totalizer 1 ▪ 9 = totalizer 2 ▪ 10 = totalizer 3

PROFIBUS DP

Manufacturer ID	0x11
Ident number	0x1560
Profile version	3.02
Device description files (GSD, DTM, DD)	<p>Information and files available at:</p> <ul style="list-style-type: none"> ▪ https://www.endress.com/download On the device product page: PRODUCTS → Product Finder → Links ▪ https://www.profibus.com

<p>Output values (from measuring instrument to automation system)</p>	<p>Analog input 1 to 4</p> <ul style="list-style-type: none"> ▪ Volume flow ▪ Mass flow ▪ Corrected volume flow ▪ Flow velocity ▪ Conductivity ▪ Corrected conductivity ▪ Temperature ▪ Electronics temperature <p>Digital input 1 to 2</p> <ul style="list-style-type: none"> ▪ Empty pipe detection ▪ Low flow cut off ▪ Verification status <p>Totalizer 1 to 3</p> <ul style="list-style-type: none"> ▪ Volume flow ▪ Mass flow ▪ Corrected volume flow
<p>Input values (from automation system to measuring instrument)</p>	<p>Analog output 1 to 2 (fixed assignment)</p> <ul style="list-style-type: none"> ▪ External temperature ▪ External density <p>Digital output 1 to 2 (fixed assignment)</p> <ul style="list-style-type: none"> ▪ Digital output 1: switch positive zero return on/off ▪ Digital output 2: start verification <p>Totalizer 1 to 3</p> <ul style="list-style-type: none"> ▪ Totalize ▪ Reset and hold ▪ Preset and hold ▪ Stop ▪ Operating mode configuration: <ul style="list-style-type: none"> ▪ Net flow total ▪ Forward flow total ▪ Reverse flow total
<p>Supported functions</p>	<ul style="list-style-type: none"> ▪ Identification & maintenance Straightforward device identification on the part of the control system and nameplate ▪ PROFIBUS upload/download Reading and writing parameters is up to ten times faster with PROFIBUS upload/download. ▪ Condensed status Straightforward and self-explanatory diagnostic information by categorizing diagnostic messages that occur
<p>Configuration of the device address</p>	<ul style="list-style-type: none"> ▪ DIP switches on the I/O electronics module ▪ Via operating tools (e.g. FieldCare)

Modbus RS485

<p>Protocol</p>	<p>Modbus Applications Protocol Specification V1.1</p>
<p>Device type</p>	<p>Slave</p>
<p>Slave address range</p>	<p>1 to 247</p>
<p>Broadcast address range</p>	<p>0</p>
<p>Function codes</p>	<ul style="list-style-type: none"> ▪ 03: Read holding register ▪ 04: Read input register ▪ 06: Write single registers ▪ 08: Diagnostics ▪ 16: Write multiple registers ▪ 23: Read/write multiple registers
<p>Broadcast messages</p>	<p>Supported by the following function codes:</p> <ul style="list-style-type: none"> ▪ 06: Write single registers ▪ 16: Write multiple registers ▪ 23: Read/write multiple registers

Supported baud rate	<ul style="list-style-type: none"> ▪ 1 200 BAUD ▪ 2 400 BAUD ▪ 4 800 BAUD ▪ 9 600 BAUD ▪ 19 200 BAUD ▪ 38 400 BAUD ▪ 57 600 BAUD ▪ 115 200 BAUD
Data transfer mode	<ul style="list-style-type: none"> ▪ ASCII ▪ RTU
Data access	<p>Each device parameter can be accessed via Modbus RS485.</p> <p> For Modbus register information, see "Description of device parameters" documentation</p>

EtherNet/IP

Protocol	<ul style="list-style-type: none"> ▪ The CIP Networks Library Volume 1: Common Industrial Protocol ▪ The CIP Networks Library Volume 2: Ethernet/IP Adaptation of CIP 		
Communication type	<ul style="list-style-type: none"> ▪ 10Base-T ▪ 100Base-TX 		
Device profile	Generic device (product type: 0x2B)		
Manufacturer ID	0x49E		
Device type ID	0x103A		
Baud rates	Automatic ¹⁰ / ₁₀₀ Mbit with half-duplex and full-duplex detection		
Polarity	Auto-polarity for automatic correction of crossed TxD and RxD pairs		
Supported CIP connections	Max. 3 connections		
Explicit connections	Max. 6 connections		
I/O connections	Max. 6 connections (scanner)		
Configuration options for measuring instrument	<ul style="list-style-type: none"> ▪ DIP switches on the electronics module for IP addressing ▪ Manufacturer-specific software (FieldCare) ▪ Add-on Profile Level 3 for Rockwell Automation control systems ▪ Web browser ▪ Electronic Data Sheet (EDS) integrated in the measuring instrument 		
Configuration of the EtherNet interface	<ul style="list-style-type: none"> ▪ Speed: 10 MBit, 100 MBit, auto (factory setting) ▪ Duplex: half-duplex, full-duplex, auto (factory setting) 		
Configuration of the device address	<ul style="list-style-type: none"> ▪ DIP switches on the electronics module for IP addressing (last octet) ▪ DHCP ▪ Manufacturer-specific software (FieldCare) ▪ Add-on Profile Level 3 for Rockwell Automation control systems ▪ Web browser ▪ Ethernet/IP tools, e.g. RSLinx (Rockwell Automation) 		
Device Level Ring (DLR)	No		
Fix input			
RPI	5 ms to 10 s (factory setting: 20 ms)		
Exclusive Owner Multicast		Instance	Size [byte]
	Instance configuration:	0x68	398
	O → T configuration:	0x66	56
	T → O configuration:	0x64	32
Exclusive Owner Multicast		Instance	Size [byte]
	Instance configuration:	0x69	-
	O → T configuration:	0x66	56
	T → O configuration:	0x64	32

Input only Multicast		Instance	Size [byte]
	Instance configuration:	0x68	398
	O → T configuration:	0xC7	-
	T → O configuration:	0x64	32
Input only Multicast		Instance	Size [byte]
	Instance configuration:	0x69	-
	O → T configuration:	0xC7	-
	T → O configuration:	0x64	32
Input Assembly	<ul style="list-style-type: none"> ■ Current device diagnostics ■ Volume flow ■ Mass flow ■ Corrected volume flow ■ Totalizer 1 ■ Totalizer 2 ■ Totalizer 3 		
Configurable Input			
RPI	5 ms to 10 s (factory setting: 20 ms)		
Exclusive Owner Multicast		Instance	Size [byte]
	Instance configuration:	0x68	398
	O → T configuration:	0x66	56
	T → O configuration:	0x65	88
Exclusive Owner Multicast		Instance	Size [byte]
	Instance configuration:	0x69	-
	O → T configuration:	0x66	56
	T → O configuration:	0x65	88
Input only Multicast		Instance	Size [byte]
	Instance configuration:	0x68	398
	O → T configuration:	0xC7	-
	T → O configuration:	0x65	88
Input only Multicast		Instance	Size [byte]
	Instance configuration:	0x69	-
	O → T configuration:	0xC7	-
	T → O configuration:	0x65	88
Configurable Input Assembly	<ul style="list-style-type: none"> ■ Volume flow ■ Corrected volume flow ■ Mass flow ■ Electronics temperature ■ Totalizer 1 to 3 ■ Flow velocity ■ Volume flow unit ■ Corrected volume flow unit ■ Mass flow unit ■ Temperature unit ■ Unit totalizer 1-3 ■ Flow velocity unit ■ Verification result ■ Verification status <p> The range of options increases if the measuring device has one or more application packages.</p>		

Fix output	
Output Assembly	<ul style="list-style-type: none"> ▪ Activation of reset totalizers 1-3 ▪ Activation of reference density compensation ▪ Activation of temperature compensation ▪ Reset totalizers 1-3 ▪ External density ▪ Density unit ▪ External temperature ▪ Activation verification ▪ Start the verification
Configuration	
Configuration Assembly	<p>Only the most common configurations are listed below.</p> <ul style="list-style-type: none"> ▪ Software write protection ▪ Mass flow unit ▪ Mass unit ▪ Volume flow unit ▪ Volume unit ▪ Corrected volume flow unit ▪ Corrected volume unit ▪ Density unit ▪ Reference density unit ▪ Temperature unit ▪ Pressure unit ▪ Length ▪ Totalizer 1-3: <ul style="list-style-type: none"> ▪ Assignment ▪ Unit ▪ Mode of operation ▪ Failure mode ▪ Alarm delay

PROFINET

Protocol	"Application layer protocol for decentral device periphery and distributed automation", version 2.3
Conformity class	B
Communication type	100 Mbps
Device profile	Application interface identifier 0xF600 Generic device
Manufacturer ID	0x11
Device type ID	0x843A
Device description files (GSD, DTM)	<p>Information and files available at:</p> <ul style="list-style-type: none"> ▪ https://www.endress.com/download On the device product page: PRODUCTS → Product Finder → Links ▪ https://www.profibus.com
Baud rates	Automatic 100 Mbit/s with full-duplex detection
Periods	From 8 ms
Polarity	Auto-polarity for automatic correction of crossed TxD and RxD pairs
Supported connections	<ul style="list-style-type: none"> ▪ 1 x AR (Application Relation) ▪ 1 x Input CR (Communication Relation) ▪ 1 x Output CR (Communication Relation) ▪ 1 x Alarm CR (Communication Relation)
Configuration options for measuring instrument	<ul style="list-style-type: none"> ▪ DIP switches on the electronics module, for device name assignment (last part) ▪ Manufacturer-specific software (FieldCare, DeviceCare) ▪ Web browser ▪ Device master file (GSD), can be read out via the integrated web server of the measuring instrument

Configuration of the device name	<ul style="list-style-type: none"> ▪ DIP switches on the electronics module, for device name assignment (last part) ▪ DCP protocol
Output values (from measuring instrument to automation system)	<p>Analog Input module (slot 1 to 10)</p> <ul style="list-style-type: none"> ▪ Volume flow ▪ Mass flow ▪ Corrected volume flow ▪ Flow velocity ▪ Conductivity ▪ Corrected conductivity ▪ Temperature ▪ Electronics temperature <p>Discrete Input module (slot 1 to 10)</p> <ul style="list-style-type: none"> ▪ Empty pipe detection ▪ Low flow cut off <p>Diagnostics Input module (slot 1 to 10)</p> <ul style="list-style-type: none"> ▪ Last diagnostics ▪ Current diagnostics <p>Totalizer 1 to 3 (slot 11 to 13)</p> <ul style="list-style-type: none"> ▪ Volume flow ▪ Mass flow ▪ Corrected volume flow <p>Heartbeat Verification module (fixed assignment) Verification status (slot 17)</p>
Input values (from automation system to measuring instrument)	<p>Analog Output module (fixed assignment)</p> <ul style="list-style-type: none"> ▪ External density (slot 14) ▪ External temperature (slot 15) <p>Discrete Output module (fixed assignment) Activate/deactivate positive zero return (slot 16)</p> <p>Totalizer 1 to 3 (slot 11 to 13)</p> <ul style="list-style-type: none"> ▪ Totalize ▪ Reset and hold ▪ Preset and hold ▪ Stop ▪ Operating mode configuration: <ul style="list-style-type: none"> ▪ Net flow total ▪ Forward flow total ▪ Reverse flow total <p>Heartbeat Verification module (fixed assignment) Start verification (slot 17)</p>
Supported functions	<ul style="list-style-type: none"> ▪ Identification & maintenance Simple device identification via: <ul style="list-style-type: none"> ▪ Control system ▪ Nameplate ▪ Measured value status The process variables are communicated with a measured value status ▪ Blinking feature via the local display for simple device identification and assignment

Administration of software options

Input/output value	Process variable	Category	Slot
Output value	Mass flow	Process variable	1...10
	Volume flow		
	Corrected volume flow		
	Temperature		
	Conductivity		
	Corrected conductivity		
	Electronics temperature		
	Flow velocity		

Input/output value	Process variable	Category	Slot
	Current device diagnostics		
	Previous device diagnostics		
Input/output value	Totalizer	Totalizer	11...13
Input value	External density	Process monitoring	14
	External temperature		15
	Flow override		16
	Verification status	Heartbeat Technology verification ¹⁾	17

1) Only available with the Heartbeat Technology application package.

Startup configuration

Startup configuration (NSU)	<p>If startup configuration is enabled, the configuration of the most important device parameters is taken from the automation system and used.</p> <p>The following configuration is taken from the automation system:</p> <ul style="list-style-type: none"> ▪ Management <ul style="list-style-type: none"> ▪ Software revision ▪ Write protection ▪ System units <ul style="list-style-type: none"> ▪ Mass flow ▪ Mass ▪ Volume flow ▪ Volume ▪ Corrected volume flow ▪ Corrected volume ▪ Density ▪ Temperature ▪ Conductivity ▪ Sensor adjustment ▪ Process parameters <ul style="list-style-type: none"> ▪ Damping (flow, conductivity, temperature) ▪ Flow override ▪ Filter options ▪ Low flow cut off <ul style="list-style-type: none"> ▪ Assign process variable ▪ Switch-on/switch-off point ▪ Pressure shock suppression ▪ Empty pipe detection <ul style="list-style-type: none"> ▪ Assign process variable ▪ Limit values ▪ Response time ▪ External compensation <ul style="list-style-type: none"> ▪ Temperature source ▪ Density source ▪ Density value ▪ Diagnostic settings ▪ Diagnostic behavior for diverse diagnostic information
-----------------------------	---

Power supply

Terminal assignment

Overview: housing version and connection versions

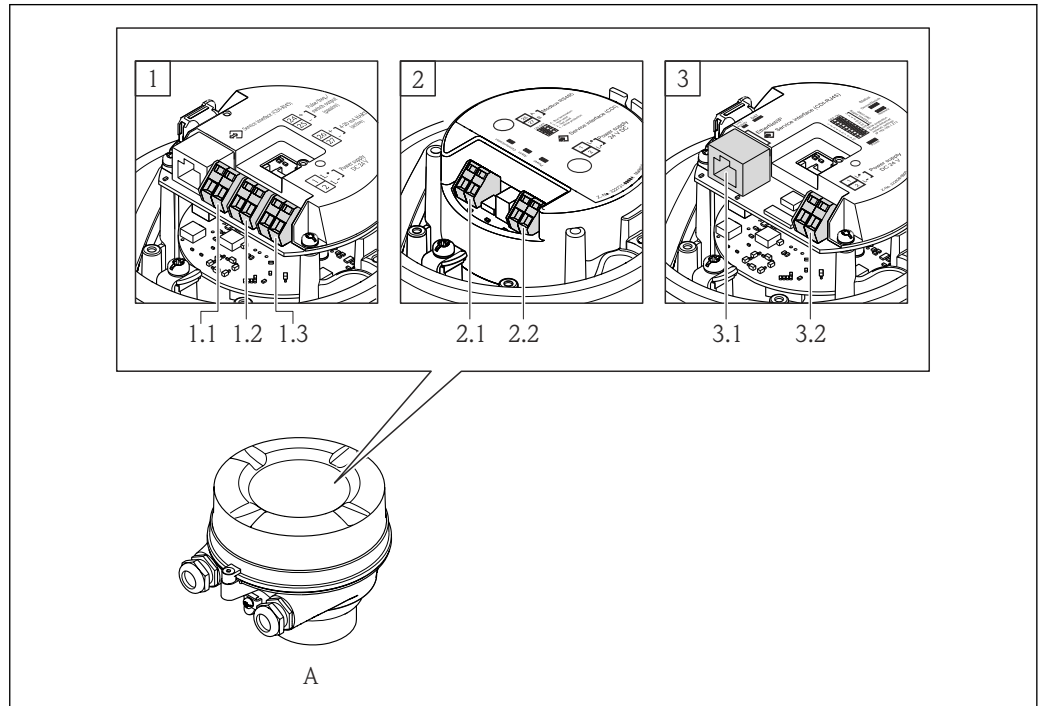

A0019825

- A Housing version: compact, aluminum coated
- 1 Connection version: 4-20 mA HART, pulse/frequency/switch output
 - 1.1 Signal transmission: pulse/frequency/switch output
 - 1.2 Signal transmission: 4-20 mA HART
 - 1.3 Supply voltage
- 2 Connection version: Modbus RS485, PROFIBUS DP
 - 2.1 Signal transmission
 - 2.2 Supply voltage
- 3 Connection version: EtherNet/IP and PROFINET
 - 3.1 Signal transmission
 - 3.2 Supply voltage

Transmitter

Connection version 4-20 mA HART with pulse/frequency/switch output

Order code for "Output", option **B**

Depending on the housing version, the transmitters can be ordered with terminals or device plugs.

Order code for "Housing"	Connection methods available		Possible options for order code "Electrical connection"
	Outputs	Power supply	
Option A	Terminals	Terminals	<ul style="list-style-type: none"> ▪ Option A: coupling M20x1 ▪ Option B: thread M20x1 ▪ Option C: thread G 1/2" ▪ Option D: thread NPT 1/2"
Option A	Device plug	Terminals	<ul style="list-style-type: none"> ▪ Option L: plug M12x1 + thread NPT 1/2" ▪ Option N: plug M12x1 + coupling M20 ▪ Option P: plug M12x1 + thread G 1/2" ▪ Option U: plug M12x1 + thread M20

Order code for "Housing"	Connection methods available		Possible options for order code "Electrical connection"
	Outputs	Power supply	
Option A	Device plug	Device plug	Option Q: 2 x plug M12x1
Order code for "Housing": Option A: compact, coated aluminum			

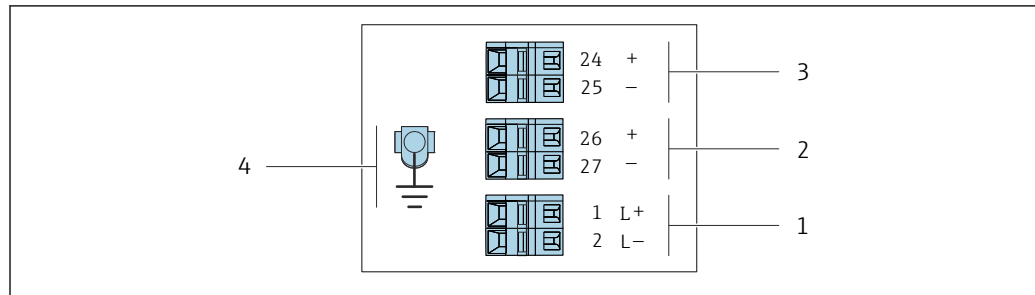

A0016886

2 Terminal assignment 4-20 mA HART with pulse/frequency/switch output

- 1 Power supply: DC 24 V
- 2 Output 1: 4-20 mA HART (active)
- 3 Output 2: pulse/frequency/switch output (passive)
- 4 Connection for cable shield (IO signals) if present and/or protective ground from the supply voltage if present. Not for option C "Ultra-compact, hygienic, stainless".

Order code for "Output"	Terminal number					
	Power supply		Output 1		Output 2	
	2 (L-)	1 (L+)	27 (-)	26 (+)	25 (-)	24 (+)
Option B	DC 24 V		4-20 mA HART (active)		Pulse/frequency/switch output (passive)	
Order code for "Output": Option B: 4-20 mA HART with pulse/frequency/switch output						

PROFIBUS DP connection version

 For use in the non-hazardous area and Zone 2/Div. 2

Order code for "Output", option **L**

Depending on the housing version, the transmitters can be ordered with terminals or device plugs.

Order code for "Housing"	Connection methods available		Possible options for order code "Electrical connection"
	Output	Power supply	
Option A	Terminals	Terminals	<ul style="list-style-type: none"> ▪ Option A: coupling M20x1 ▪ Option B: thread M20x1 ▪ Option C: thread G ½" ▪ Option D: thread NPT ½"
Option A	Device plug	Terminals	<ul style="list-style-type: none"> ▪ Option L: plug M12x1 + thread NPT ½" ▪ Option N: plug M12x1 + coupling M20 ▪ Option P: plug M12x1 + thread G ½" ▪ Option U: plug M12x1 + thread M20
Option A	Device plug	Device plug	Option Q : 2 x plug M12x1

Order code for "Housing":
Option **A**: compact, coated aluminum

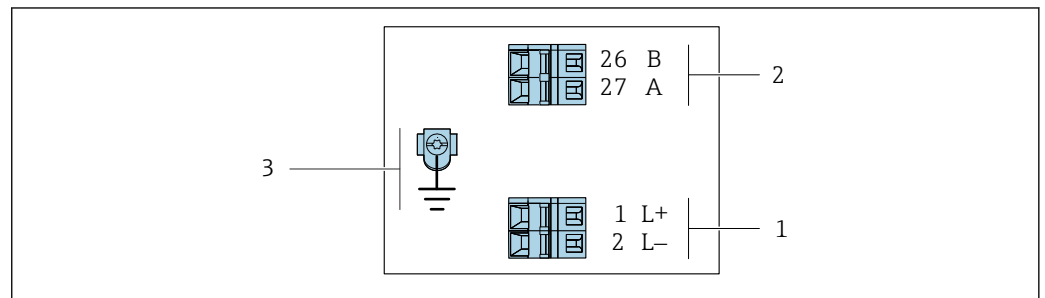

A0022716

 3 PROFIBUS DP terminal assignment

- 1 Power supply: DC 24 V
- 2 PROFIBUS DP
- 3 Connection for cable shield (IO signals) if present and/or protective ground from the supply voltage if present. Not for option C "Ultra-compact, hygienic, stainless".

Order code for "Output"	Terminal number			
	Power supply		Output	
	2 (L-)	1 (L+)	26 (RxD/TxD-P)	27 (RxD/TxD-N)
Option L	DC 24 V		B	A

Order code for "Output":
Option **L**: PROFIBUS DP, for use in non-hazardous areas and Zone 2/Div. 2

Modbus RS485 connection version

Order code for "Output", option **M**

Depending on the housing version, the transmitters can be ordered with terminals or device plugs.

Order code for "Housing"	Connection methods available		Possible options for order code "Electrical connection"
	Output	Power supply	
Option A	Terminals	Terminals	<ul style="list-style-type: none"> ▪ Option A: coupling M20x1 ▪ Option B: thread M20x1 ▪ Option C: thread G ½" ▪ Option D: thread NPT ½"
Option A	Device plug	Terminals	<ul style="list-style-type: none"> ▪ Option L: plug M12x1 + thread NPT ½" ▪ Option N: plug M12x1 + coupling M20 ▪ Option P: plug M12x1 + thread G ½" ▪ Option U: plug M12x1 + thread M20
Option A	Device plug	Device plug	Option Q : 2 x plug M12x1
Order code for "Housing": Option A : compact, coated aluminum			

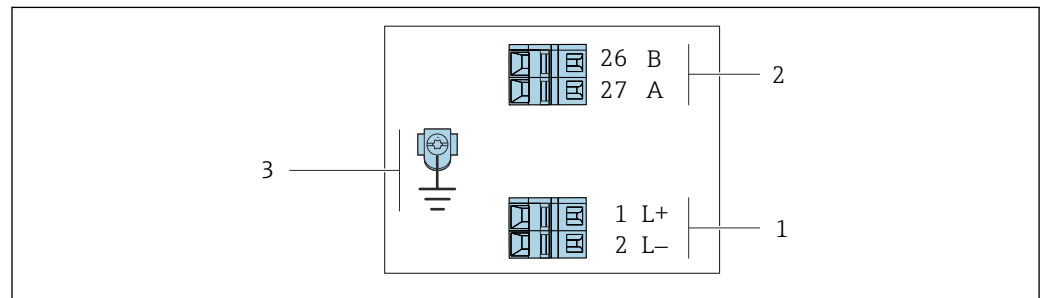

A0019528

4 *Modbus RS485 terminal assignment*

- 1 Power supply: DC 24 V
- 2 Modbus RS485
- 3 Connection for cable shield (IO signals) if present and/or protective ground from the supply voltage if present. Not for option C "Ultra-compact, hygienic, stainless".

Order code for "Output"	Terminal number			
	Power supply		Output	
	1 (L+)	2 (L-)	26 (B)	27 (A)
Option M	DC 24 V		Modbus RS485	
Order code for "Output": Option M : Modbus RS485				

Modbus RS485 connection version



For use in the intrinsically safe area. Connection via Safety Barrier Promass 100.

Order code for "Output", option **M**

EtherNet/IP connection version

Order code for "Output", option **N**

Depending on the housing version, the transmitters can be ordered with terminals or device plugs.

Order code for "Housing"	Connection methods available		Possible options for order code "Electrical connection"
	Output	Power supply	
Option A	Device plug	Terminals	<ul style="list-style-type: none"> ■ Option L: plug M12x1 + thread NPT ½" ■ Option N: plug M12x1 + coupling M20 ■ Option P: plug M12x1 + thread G ½" ■ Option U: plug M12x1 + thread M20
Option A	Device plug	Device plug	Option Q : 2 x plug M12x1
Order code for "Housing": Option A : compact, coated aluminum			

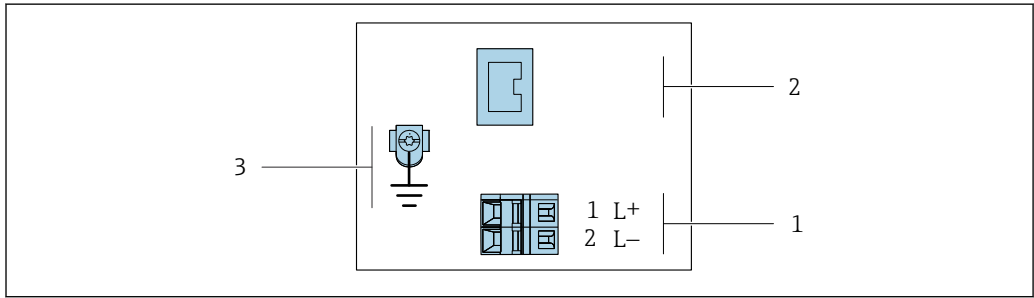

5 EtherNet/IP terminal assignment

- 1 Power supply: DC 24 V
- 2 EtherNet/IP
- 3 Connection for cable shield (IO signals) if present and/or protective ground from the supply voltage if present. Not for option C "Ultra-compact, hygienic, stainless".

Order code for "Output"	Terminal number		Output Device plug M12x1
	Power supply 2 (L-)	1 (L+)	
Option N	DC 24 V		EtherNet/IP
Order code for "Output": Option N : EtherNet/IP			

PROFINET connection version

Order code for "Output", option **R**

Depending on the housing version, the transmitters can be ordered with terminals or device plugs.

Order code for "Housing"	Connection methods available		Possible options for order code "Electrical connection"
	Output	Power supply	
Option A	Device plug → ☰ 25	Terminals	<ul style="list-style-type: none"> ■ Option L: plug M12x1 + thread NPT ½" ■ Option N: plug M12x1 + coupling M20 ■ Option P: plug M12x1 + thread G ½" ■ Option U: plug M12x1 + thread M20
Option A	Device plug → ☰ 25	Device plug → ☰ 25	Option Q : 2 x plug M12x1

Order code for "Housing":
Option **A**: compact, coated aluminum

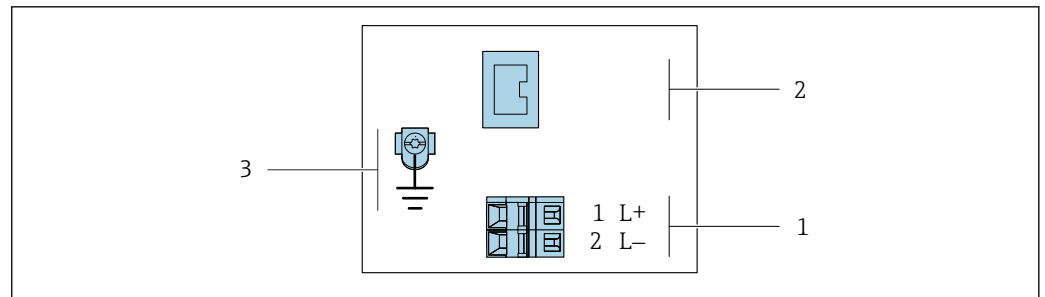

A0017054

☰ 6 PROFINET terminal assignment

- 1 Power supply: DC 24 V
- 2 PROFINET
- 3 Connection for cable shield (IO signals) if present and/or protective ground from the supply voltage if present. Not for option C "Ultra-compact, hygienic, stainless".

Order code for "Output"	Terminal number		Output Device plug M12x1
	Power supply 2 (L-)	1 (L+)	
Option R	DC 24 V		PROFINET

Order code for "Output":
Option **R**: PROFINET

Pin assignment, device plug

- i** Order codes for the M12x1 plugs, see the "Order code for **electrical connection**" column:
 - 4-20 mA HART, pulse/frequency/switch output → ☰ 19
 - PROFIBUS DP → ☰ 21
 - Modbus RS485 → ☰ 22
 - EtherNet/IP → ☰ 24
 - PROFINET → ☰ 25

Supply voltage

For all connection versions (device side), male connection (plug)

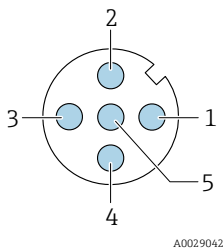
 A0029042	Pin		Assignment
	1	L+	
2			Not used
3			Not used
4	L-		DC 24 V
5			Grounding/shielding ¹⁾
Coding		Plug/socket	
A		Plug	

- 1) Connection for protective ground and shielding from the supply voltage if present. Not for option C "Ultra-compact, hygienic, stainless". Note: There is a metallic connection between the union nut of the M12 cable and the transmitter housing.



The following is recommended as a socket:

- Binder, series 763, part no. 79 3440 35 05
- Alternatively: Phoenix part no. 1682951 SAC-5P-5.0-PUR/M12FS SH
 - With the order code for "Output", option **B**: 4-20 mA HART, pulse/frequency/switch output
 - With the order code for "Output", option **N**: EtherNet/IP
- When using the device in a hazardous location: Use a suitably certified socket.

4-20 mA HART with pulse/frequency/switch output

Device plug for signal transmission (device side), female connection

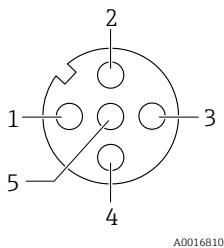
 A0016810	Pin		Assignment
	1	+	
2	-		4-20 mA HART (active)
3	+		Pulse/frequency/switch output (passive)
4	-		Pulse/frequency/switch output (passive)
5			Shielding ¹⁾
Coding		Plug/socket	
A		Socket	

- 1) Connection for cable shield (IO signals) if present. Not for option C "Ultra-compact, hygienic, stainless". Note: There is a metallic connection between the union nut of the M12 cable and the transmitter housing.



- Recommended plug: Binder, series 763, part no. 79 3439 12 05
- When using the device in a hazardous location, use a suitably certified plug.

PROFIBUS DP



For use in the non-hazardous area and Zone 2/Div. 2.

Device plug for signal transmission (device side)

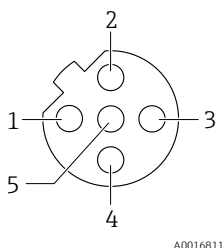
 A0016811	Pin		Assignment
	1		
2	A		PROFIBUS DP
3			Not used
4	B		PROFIBUS DP
5			Shielding ¹⁾

	Coding	Plug/socket
	B	Socket

- 1) Connection for cable shield (IO signals) if present. Not for option C "Ultra-compact, hygienic, stainless".
 Note: There is a metallic connection between the union nut of the M12 cable and the transmitter housing.



- Recommended plug: Binder, series 763, part no. 79 4449 20 05
- When using the device in a hazardous location, use a suitably certified plug.

MODBUS RS485

Device plug for signal transmission (device side)

	Pin	Assignment	
	1		Not used
	2	A	Modbus RS485
	3		Not used
	4	B	Modbus RS485
	5		Shielding ¹⁾
	Coding	Plug/socket	
	B	Socket	

- 1) Connection for cable shield (IO signals) if present. Not for option C "Ultra-compact, hygienic, stainless".
 Note: There is a metallic connection between the union nut of the M12 cable and the transmitter housing.



- Recommended plug: Binder, series 763, part no. 79 4449 20 05
- When using the device in a hazardous location, use a suitably certified plug.

EtherNet/IP

Device plug for signal transmission (device side)

	Pin	Assignment	
	1	+	Tx
	2	+	Rx
	3	-	Tx
	4	-	Rx
	Coding	Plug/socket	
	D	Socket	



- There is a metallic connection between the union nut of the M12 cable and the transmitter housing.
- Recommended plug:
 - Binder, series 763, part no. 99 3729 810 04
 - Phoenix, part no. 1543223 SACC-M12MSD-4Q
 - When using the device in a hazardous location, use a suitably certified plug.

PROFINET

Device plug for signal transmission (device side)

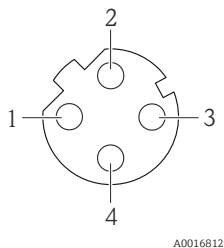
	Pin	Assignment	
	1	+	TD +
	2	+	RD +
	3	-	TD -
	4	-	RD -
Coding		Plug/socket	
D		Socket	

- i**
- There is a metallic connection between the union nut of the M12 cable and the transmitter housing.
 - Recommended plug:
 - Binder, series 763, part no. 99 3729 810 04
 - Phoenix, part no. 1543223 SACC-M12MSD-4Q
 - When using the device in a hazardous location, use a suitably certified plug.

Supply voltage

The power unit must be tested to ensure it meets safety requirements (e.g. PELV, SELV).

Transmitter

For device version with all communication types: DC 20 to 30 V

Power consumption**Transmitter**

Order code for "Output"	Maximum Power consumption
Option B : 4-20 mA HART with pulse/frequency/switch output	3.5 W
Option L : PROFIBUS DP	3.5 W
Option M : Modbus RS485	3.5 W
Option N : EtherNet/IP	3.5 W
Option R : PROFINET	3.5 W

Current consumption**Transmitter**

Order code for "Output"	Maximum Current consumption	Maximum switch-on current
Option B : 4-20mA HART, pul./freq./switch output	145 mA	18 A (< 0.125 ms)
Option L : PROFIBUS DP	145 mA	18 A (< 0.125 ms)
Option M : Modbus RS485	90 mA	10 A (< 0.8 ms)
Option N : EtherNet/IP	145 mA	18 A (< 0.125 ms)
Option R : PROFINET	145 mA	18 A (< 0.125 ms)

Device fuse

Fine-wire fuse (slow-blow) T2A

Power supply failure

- Totalizers stop at the last value measured.
- Depending on the device version, the configuration is retained in the device memory or in the pluggable data memory (HistoROM DAT).
- Error messages (incl. total operated hours) are stored.



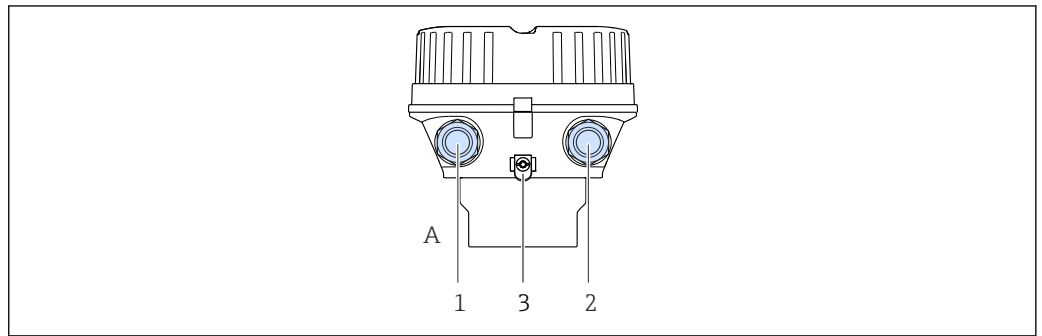

Electrical connection

Transmitter connection



A0019824

- A Housing version: compact, coated, aluminum
- 1 Cable entry or device plug for signal transmission
- 2 Cable entry or device plug for supply voltage
- 3 Ground terminal. Cable lugs, pipe clips or ground disks are recommended for optimization of the grounding/shielding.

-  Terminal assignment →  19
-  Pin assignment, device plug →  25

 In the case of device versions with a connector, the transmitter housing does not need to be opened to connect the signal cable or power supply cable.

Connection examples

Pulse output/frequency output/switch output

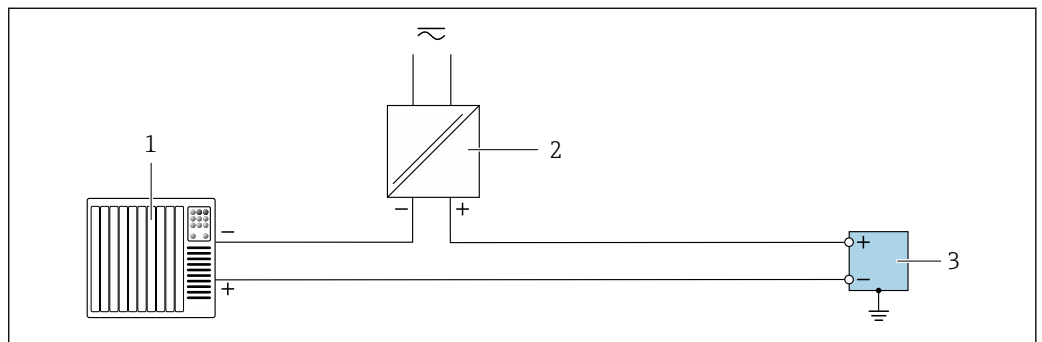

A0055855

 7 Connection example for pulse output/frequency output/switch output (passive)

- 1 Automation system with pulse input/frequency input/switch input (e.g. PLC)
- 2 Power supply
- 3 Transmitter with pulse output/frequency output/switch output (passive)

Current output 4 to 20 mA HART

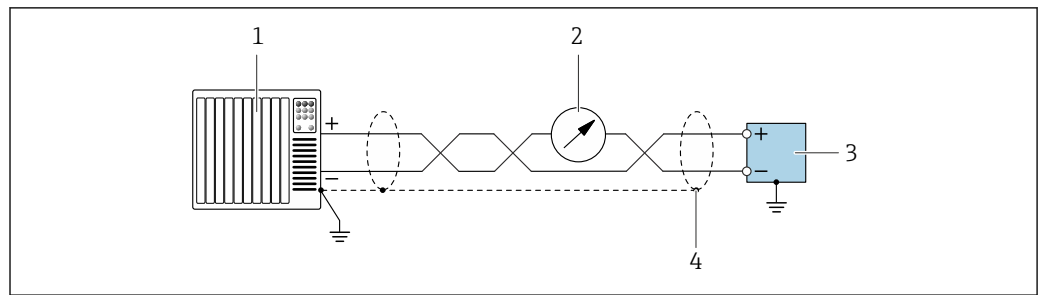

A0055862

 8 Connection example for 4 to 20 mA current output with HART (active)

- 1 Automation system with 4 to 20 mA current input with HART (e.g. PLC)
- 2 Optional display unit: Note maximum load
- 3 Transmitter with 4 to 20 mA current output with HART (active)
- 4 Ground cable shield at one end. For installations in compliance with NAMUR NE 89, grounding of the cable shield on both sides is required.

Modbus RS485

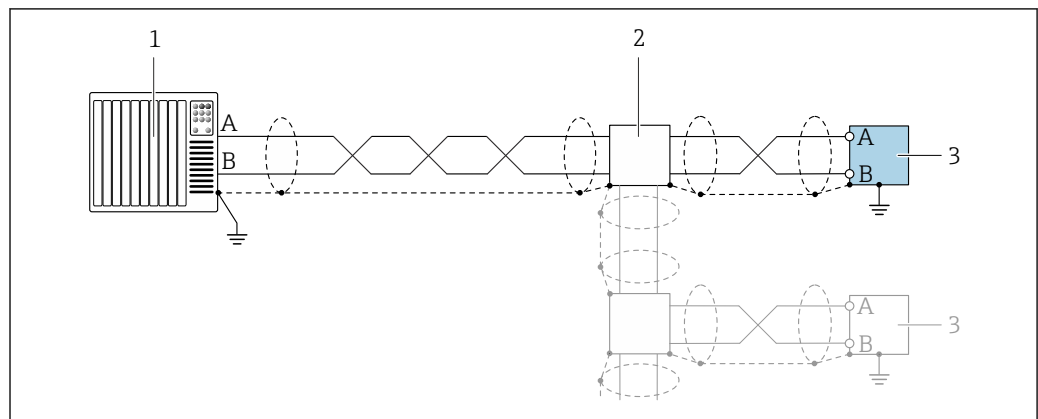

A0055863

 9 Connection example for Modbus RS485

- 1 Automation system with Modbus master (e.g. PLC)
- 2 Optional distribution box
- 3 Transmitter with Modbus RS485

PROFIBUS DP

 See <https://www.profibus.com> "PROFIBUS Installation Guidelines".

PROFINET

 See <https://www.profibus.com> "PROFINET Planning guideline".

EtherNet/IP

 See <https://www.odva.org> "EtherNet/IP Media Planning & Installation Manual".

Potential equalization

Requirements

For potential equalization:

- Pay attention to in-house grounding concepts
- Take account of operating conditions, such as the pipe material and grounding
- Connect the medium, sensor and transmitter to the same electric potential
- Use a ground cable with a minimum cross-section of 6 mm² (10 AWG) and a cable lug for potential equalization connections

Terminals

Transmitter

Spring terminals for wire cross-sections 0.5 to 2.5 mm² (20 to 14 AWG)

Cable entries

- Cable gland: M20 × 1.5 with cable Ø 6 to 12 mm (0.24 to 0.47 in)
- Thread for cable entry:
 - M20
 - G ½"
 - NPT ½"

Cable specification

Permitted temperature range

- The installation guidelines that apply in the country of installation must be observed.
- The cables must be suitable for the minimum and maximum temperatures to be expected.

Power supply cable (incl. conductor for the inner ground terminal)

Standard installation cable is sufficient.

Signal cable

 For custody transfer, all signal lines must be shielded cables (tinned copper braiding, optical coverage ≥ 85 %). The cable shield must be connected on both sides.

4 to 20 mA current output (without HART)

Standard installation cable is sufficient.

Pulse/frequency/switch output

Standard installation cable is sufficient.

Current output 4 to 20 mA HART

Shielded twisted-pair cable.

 See <https://www.fieldcommgroup.org> "HART PROTOCOL SPECIFICATIONS".

Modbus RS485

Shielded twisted-pair cable.

 See <https://modbus.org> "MODBUS over Serial Line Specification and Implementation Guide".

PROFIBUS DP

Shielded twisted-pair cable. Cable type A is recommended.

 See <https://www.profibus.com> "PROFIBUS Installation Guidelines".

PROFINET

Only PROFINET cables.

 See <https://www.profibus.com> "PROFINET Planning guideline".

EtherNet/IP

Twisted-pair Ethernet CAT 5 or better.

 See <https://www.odva.org> "EtherNet/IP Media Planning & Installation Manual".

Performance characteristics

Reference operating conditions

- Error limits following DIN EN 29104, in future ISO 20456
- Water, typically +15 to +45 °C (+59 to +113 °F); 0.5 to 7 bar (7.3 to 101 psi)
- Data as indicated in the calibration protocol
- Accuracy based on accredited calibration rigs according to ISO 17025

Maximum measurement error

Maximum permissible error under reference operating conditions

o.r. = of reading

Volume flow

- $\pm 0.5\%$ o.r. ± 1 mm/s (0.04 in/s)
- Optional: $\pm 0.2\%$ o.r. ± 2 mm/s (0.08 in/s)



Fluctuations in the supply voltage do not have any effect within the specified range.

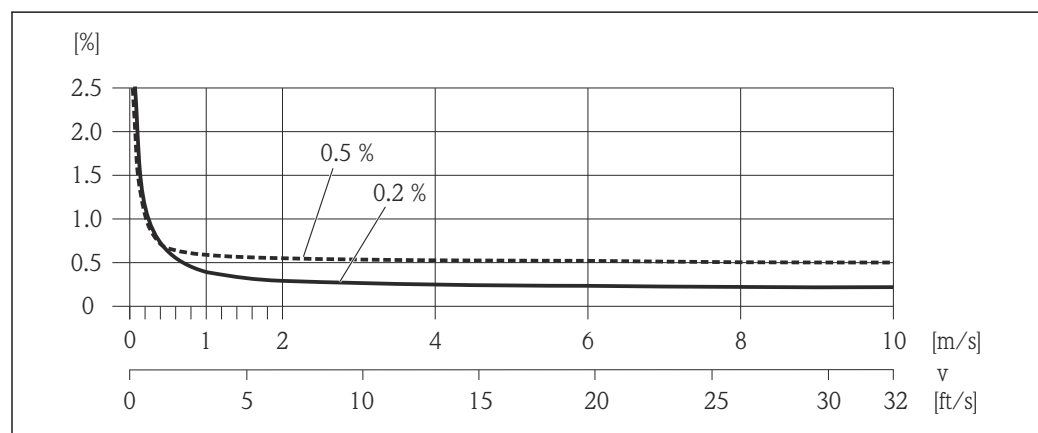

A0005531

10 Maximum measurement error in % o.r.

Electrical conductivity

Max. measurement error not specified.

Accuracy of outputs



The output accuracy must be factored into the measurement error if analog outputs are used; but can be ignored for fieldbus outputs (e.g. Modbus RS485, EtherNet/IP).

The outputs have the following base accuracy specifications.

Current output

Accuracy	Max. ± 5 μ A
----------	----------------------

Pulse/frequency output

o.r. = of reading

Accuracy	Max. ± 50 ppm o.r. (over the entire ambient temperature range)
----------	--

Repeatability

o.r. = of reading

Volume flow

Max. $\pm 0.1\%$ o.r. ± 0.5 mm/s (0.02 in/s)

Electrical conductivity

Max. $\pm 5\%$ o.r.

Temperature measurement response time

$T_{90} < 15$ s

Influence of ambient temperature

Current output

o.r. = of reading

Temperature coefficient	Max. ± 0.005 % o.r./°C
-------------------------	----------------------------

Pulse/frequency output

Temperature coefficient	No additional effect. Included in accuracy.
-------------------------	---

Mounting

Mounting location

- Do not install the device at the highest point of the pipe.
- Do not install the device upstream from a free pipe outlet in a down pipe.

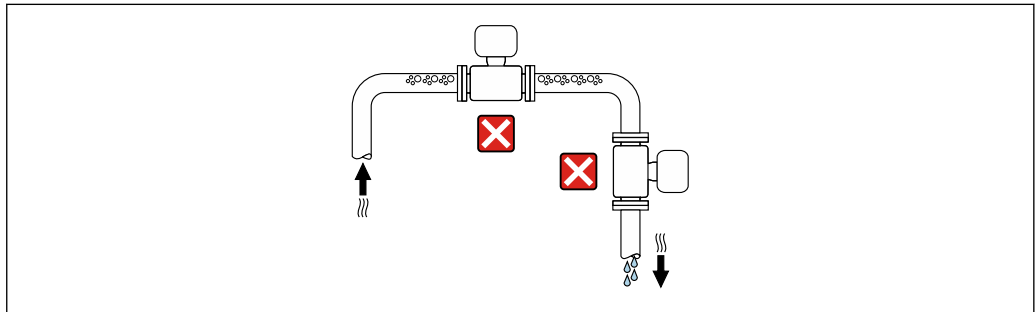

A0042313

The device should ideally be installed in an ascending pipe.

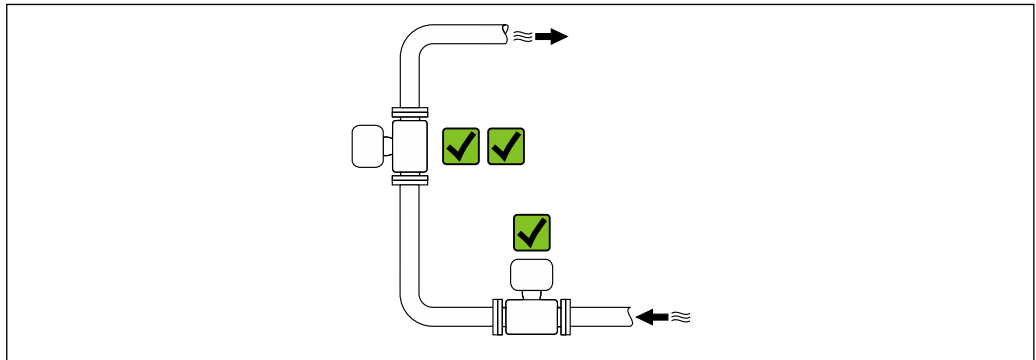

A0042317

Installation near valves

Install the device in the direction of flow upstream from the valve.

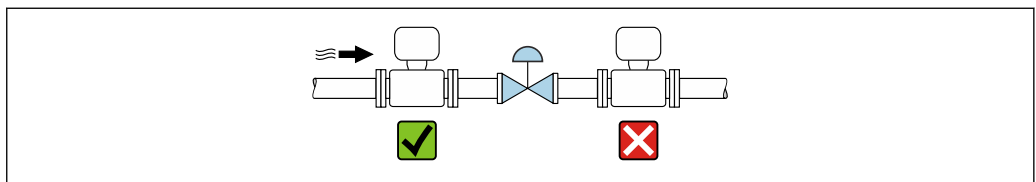

A0041091

Installation upstream from a down pipe

NOTICE

Negative pressure in the measuring pipe can damage the liner!

- ▶ If installing upstream of down pipes whose length $h \geq 5 \text{ m}$ (16.4 ft): install a siphon with a vent valve downstream of the device.

 This arrangement prevents the flow of liquid stopping in the pipe and air entrainment.

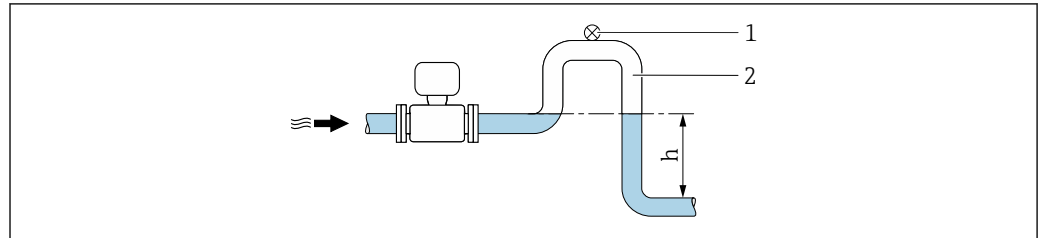

A0028981

- 1 Vent valve
- 2 Pipe siphon
- h Length of down pipe

Installation with partially filled pipes

- Partially filled pipes with a gradient require a drain-type configuration.
- The installation of a cleaning valve is recommended.

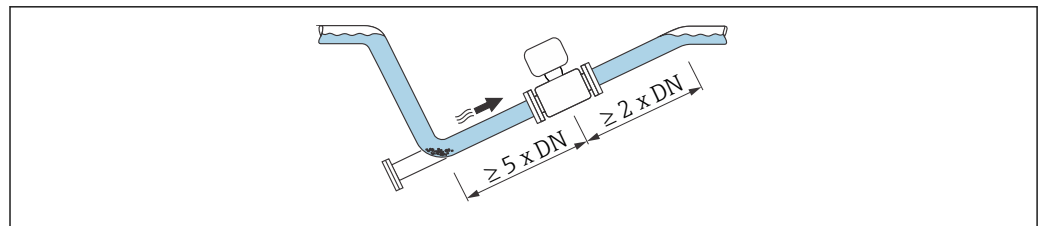

A0041088

Installation near pumps



NOTICE

Negative pressure in the measuring tube can damage the liner!

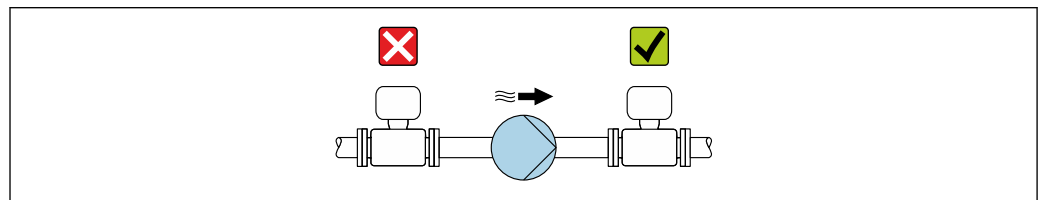
- ▶ In order to maintain the system pressure, install the device in the flow direction downstream from the pump.
- ▶ Install pulsation dampers if reciprocating, diaphragm or peristaltic pumps are used.



A0041083

-  Information on the liner's resistance to partial vacuum
- Information on the measuring system's resistance to vibration and shock →  39

Installation of very heavy devices

Support required for nominal diameters of $\text{DN} \geq 350 \text{ mm}$ (14 in).

NOTICE

Damage to the device!

If incorrect support is provided, the sensor housing could buckle and the internal magnetic coils could be damaged.

- ▶ Only provide supports at the pipe flanges.

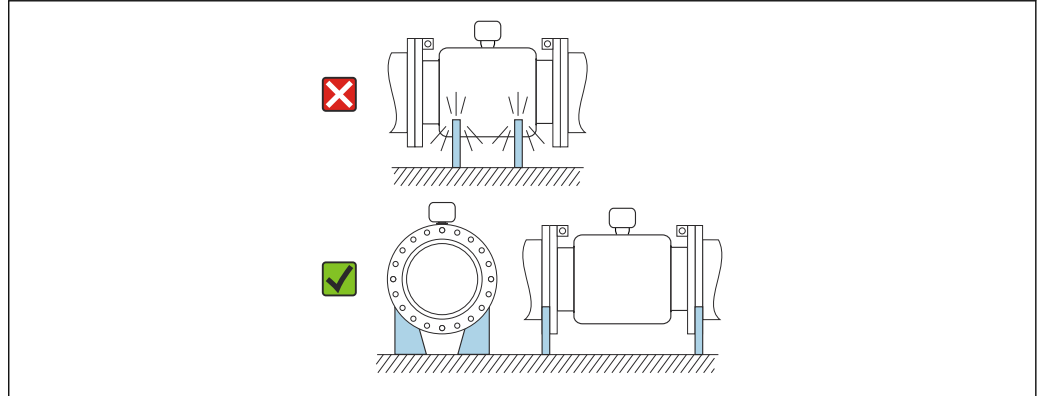

A0041087

Installation in event of pipe vibrations

NOTICE

Pipe vibrations can damage the device!

- ▶ Do not expose the device to strong vibrations.
- ▶ Support the pipe and fix it in place.
- ▶ Support the device and fix it in place.

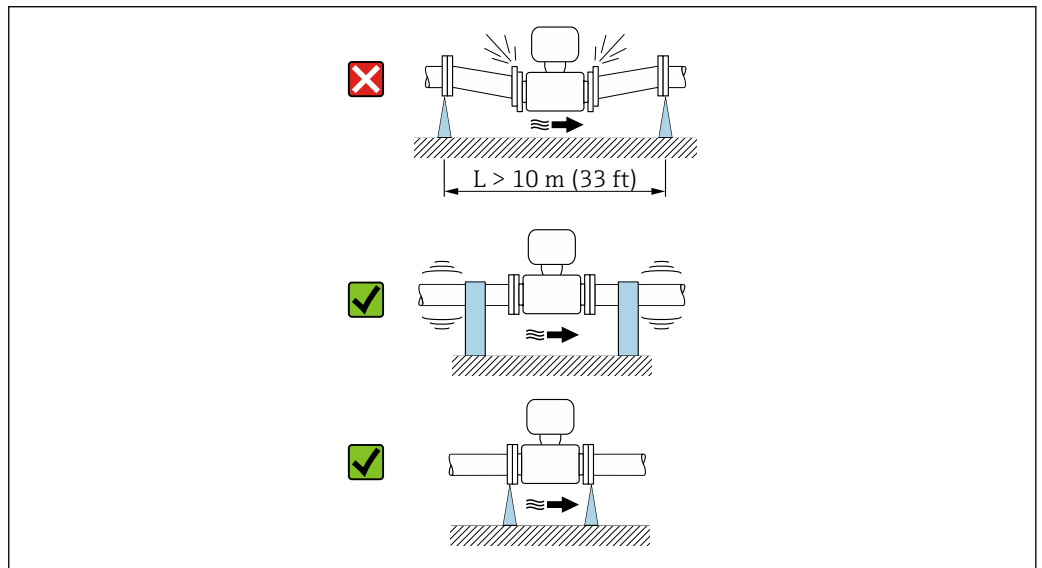







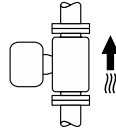

A0041092

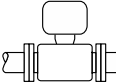
 Information on the measuring system's resistance to vibration and shock →  39

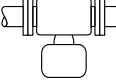
Orientation

The direction of the arrow on the nameplate helps you to install the measuring device according to the flow direction (direction of medium flow through the piping).

Orientation		Recommendation
Vertical orientation	 A0015591	
Horizontal orientation, transmitter at top	 A0015589	 ¹⁾
Horizontal orientation, transmitter at bottom	 A0015590	 ^{2) 3)}  ⁴⁾
Horizontal orientation, transmitter at side	 A0015592	

- 1) Applications with low process temperatures may reduce the ambient temperature. To maintain the minimum ambient temperature for the transmitter, this orientation is recommended.
- 2) Applications with high process temperatures may increase the ambient temperature. To maintain the maximum ambient temperature for the transmitter, this orientation is recommended.
- 3) To prevent the electronics from overheating in the event of strong heat formation (e.g. CIP or SIP cleaning process), install the device with the transmitter part pointing downwards.
- 4) With the empty pipe detection function switched on: empty pipe detection only works if the transmitter housing is pointing upwards.

Vertical

Optimum for self-emptying pipe systems and for use in conjunction with empty pipe detection.

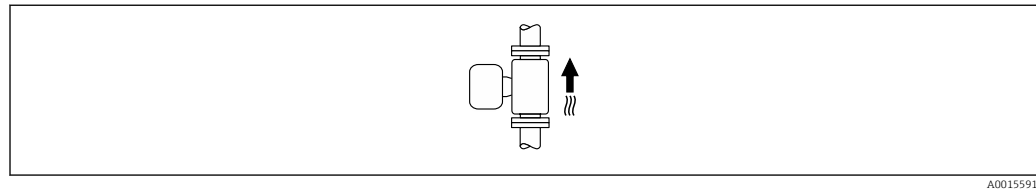

A0015591

Horizontal

- Ideally, the measuring electrode plane should be horizontal. This prevents brief insulation of the measuring electrodes by entrained air bubbles.
- Empty pipe detection only works if the transmitter housing is pointing upwards as otherwise there is no guarantee that the empty pipe detection function will actually respond to a partially filled or empty measuring tube.

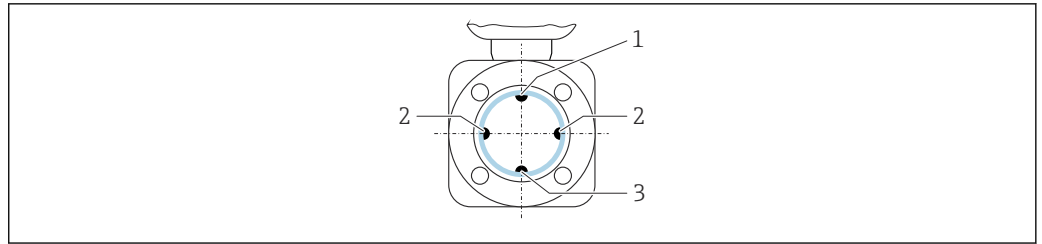

A0029344

- 1 EPD electrode for empty pipe detection
- 2 Measuring electrodes for signal detection
- 3 Reference electrode for potential equalization

i Measuring instruments with tantalum or platinum electrodes can be ordered without an EPD electrode. In this case, empty pipe detection is performed via the measuring electrodes.

Inlet and outlet runs

Installation with inlet and outlet runs

Installation with elbows, pumps or valves

To avoid a vacuum and to maintain the specified level of measurement accuracy, if possible install the device upstream from assemblies that produce turbulence (e.g. valves, T-sections) and downstream from pumps.

Maintain straight, unimpeded inlet and outlet runs.

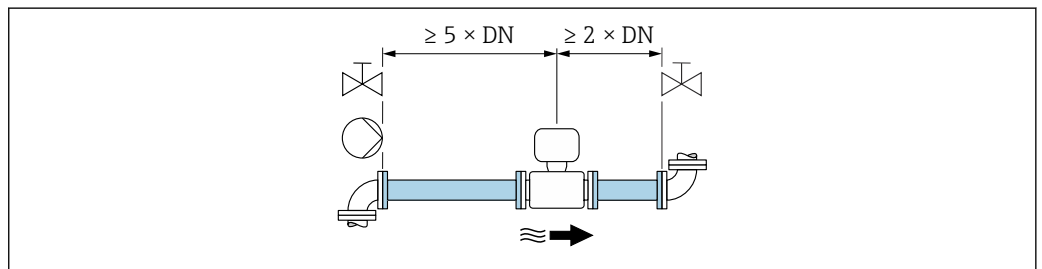

A0028997

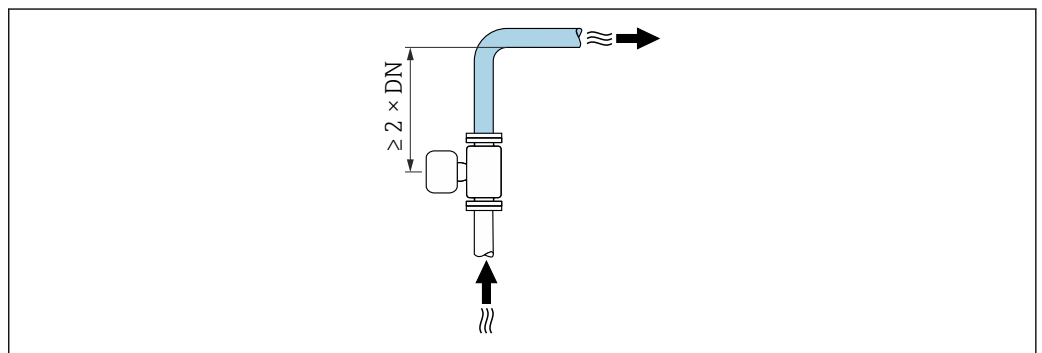

A0042132

Installation without inlet and outlet runs

Depending on the device design and installation location, the inlet and outlet runs can be reduced or omitted entirely.

Devices and possible order options on request.

i **Maximum measurement error**
When the device is installed with the inlet and outlet runs described, a maximum measurement error of $\pm 0.5\%$ of the reading can be guaranteed.

Installation before or after bends

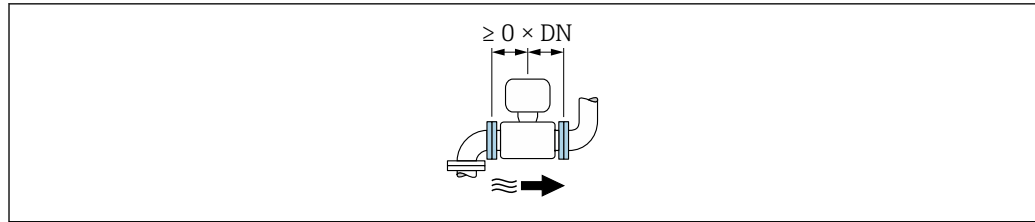

Installation downstream of pumps

Installation upstream of valves

Installation downstream of valves

Adapters

The sensor can also be installed in larger-diameter pipes with the aid of suitable adapters according to DIN EN 545 (double-flange reducers). The resultant increase in the rate of flow improves measuring accuracy with very slow-moving fluids.

The nomogram shown here can be used to calculate the pressure loss caused by reducers and expanders:

- Calculate the ratio of the diameters d/D .
- From the nomogram read off the pressure loss as a function of flow velocity (downstream from the reduction) and the d/D ratio.

 The nomogram only applies to liquids with a viscosity similar to that of water.

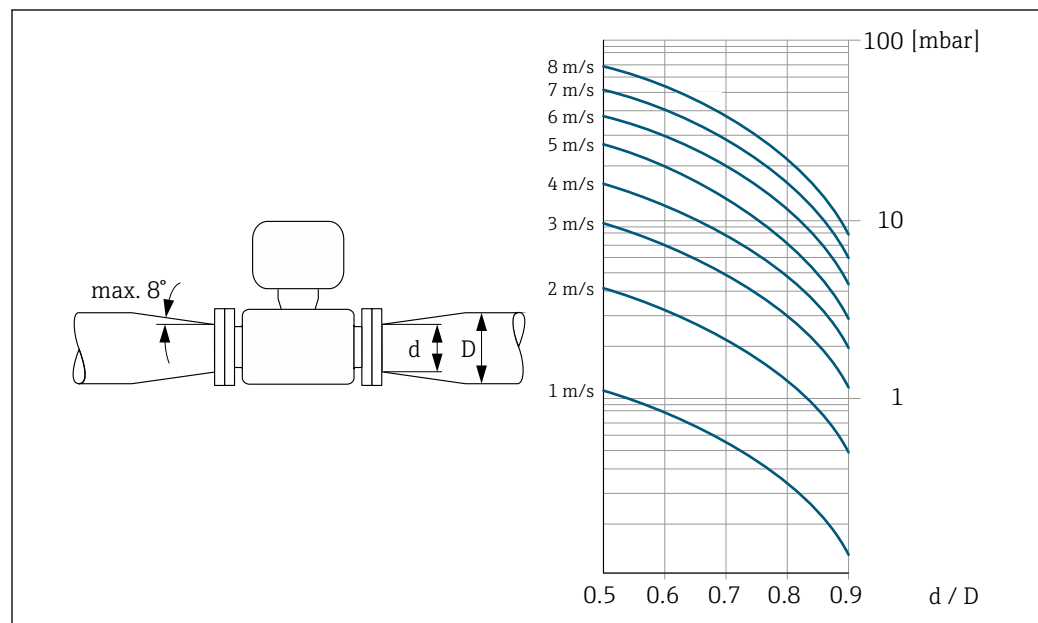

A0029002

Environment

Ambient temperature range

Transmitter	-40 to +60 °C (-40 to +140 °F)
Local display	-20 to +60 °C (-4 to +140 °F); readability of the local display may be impaired at temperatures outside the temperature range.

Sensor	<ul style="list-style-type: none"> ■ Process connection material, carbon steel: -10 to +60 °C (+14 to +140 °F) ■ Process connection material, stainless steel: -40 to +60 °C (-40 to +140 °F)
Liner	Do not exceed or fall below the permitted temperature range of the liner .

If operating outdoors:





- Install the measuring instrument in a shady location.
- Avoid direct sunlight, particularly in warm climatic regions.
- Avoid direct exposure to weather conditions.

Storage temperature	<p>The storage temperature corresponds to the operating temperature range of the transmitter and the sensor →  38.</p> <ul style="list-style-type: none"> ■ Protect the measuring device against direct sunlight during storage in order to avoid unacceptably high surface temperatures. ■ Select a storage location where moisture cannot collect in the measuring device as fungus or bacteria infestation can damage the liner. ■ If protection caps or protective covers are mounted these should never be removed before installing the measuring device.
----------------------------	---

Degree of protection	<p>Transmitter and sensor</p> <ul style="list-style-type: none"> ■ Standard: IP66/67, Type 4X enclosure, suitable for pollution degree 4 ■ When the housing is open: IP20, Type 1 enclosure, suitable for pollution degree 2 ■ Display module: IP20, Type 1 enclosure, suitable for pollution degree 2
-----------------------------	--

Vibration-resistance and shock resistance	<p>Vibration sinusoidal, in accordance with IEC 60068-2-6</p> <ul style="list-style-type: none"> ■ 2 to 8.4 Hz, 3.5 mm peak ■ 8.4 to 2 000 Hz, 1 g peak <p>Vibration broad-band random, according to IEC 60068-2-64</p> <ul style="list-style-type: none"> ■ 10 to 200 Hz, 0.003 g²/Hz ■ 200 to 2 000 Hz, 0.001 g²/Hz ■ Total: 1.54 g rms <p>Shock half-sine, according to IEC 60068-2-27</p> <p>6 ms 30 g</p> <p>Rough handling shocks according to IEC 60068-2-31</p>
--	--

Mechanical load	<p>Sensor connection housing:</p> <ul style="list-style-type: none"> ■ Protect against mechanical effects, such as shock or impact ■ Do not use as a ladder or climbing aid
------------------------	---

Electromagnetic compatibility (EMC)	<ul style="list-style-type: none"> ■ As per IEC/EN 61326 ■ As per NAMUR Recommendation 21 (NE 21), NAMUR Recommendation 21 (NE 21) is fulfilled when installed in accordance with NAMUR Recommendation 98 (NE 98) ■ As per IEC/EN 61000-6-2 and IEC/EN 61000-6-4 ■ Complies with emission limits for industry as per EN 55011 (Class A) ■ Device version with PROFIBUS DP: Complies with emission limits for industry as per EN 50170 Volume 2, IEC 61784 <p> The following applies for PROFIBUS DP: If baud rates > 1.5 MBaud, an EMC cable entry must be used and the cable shield must continue as far as the terminal wherever possible.</p> <p> Details are provided in the Declaration of Conformity.</p> <p> This unit is not intended for use in residential environments and cannot guarantee adequate protection of the radio reception in such environments.</p> <p> The selection of a sensor with a steel housing is recommended for use in the vicinity of electrical power supply lines with strong currents.</p>
--	--

Process

Medium temperature range

 The permitted fluid temperature in custody transfer is 0 to +50 °C (+32 to +122 °F).

Conductivity

≥5 µS/cm for liquids in general.

Flow limit

The diameter of the pipe and the flow rate determine the nominal diameter of the sensor. The optimum velocity of flow is between 2 to 3 m/s (6.56 to 9.84 ft/s). Also match the velocity of flow (v) to the physical properties of the medium:

- $v < 2$ m/s (6.56 ft/s): for abrasive media (e.g. potter's clay, lime milk, ore slurry)
- $v > 2$ m/s (6.56 ft/s): for media producing buildup (e.g. wastewater sludge)

 A necessary increase in the flow velocity can be achieved by reducing the sensor nominal diameter.

Pressure loss

- No pressure loss occurs if the sensor is installed in a pipe with the same nominal diameter.
- Pressure losses for configurations incorporating adapters according to DIN EN 545 →  38

System pressure

Installation near pumps →  34

Vibrations

Installation in event of pipe vibrations →  35

Magnetism and static electricity

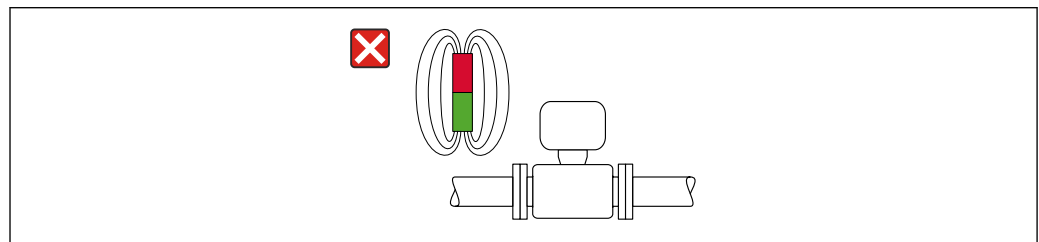

A0042152

 11 Avoid magnetic fields

Mechanical construction

Dimensions in SI units

Compact version

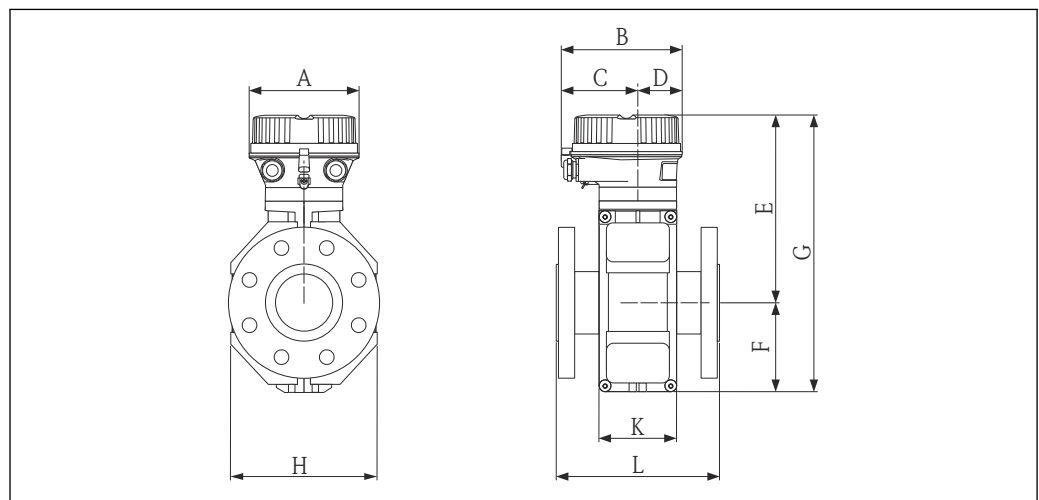

A0019491

Order code for "Housing", option A "Compact, coated aluminum"

DN [mm]	A [mm]	B [mm]	C [mm]	D [mm]	E ^{1) 2)} [mm]	F [mm]	G ^{1) 2)} [mm]	H [mm]	K [mm]	L ³⁾ [mm]
15	136	147.5	93.5	54	197	84	281	120	94	200
25	136	147.5	93.5	54	197	84	281	120	94	200
32	136	147.5	93.5	54	197	84	281	120	94	200
40	136	147.5	93.5	54	197	84	281	120	94	200
50	136	147.5	93.5	54	197	84	281	120	94	200
65	136	147.5	93.5	54	222	109	331	180	94	200
80	136	147.5	93.5	54	222	109	331	180	94	200
100	136	147.5	93.5	54	222	109	331	180	94	250
125	136	147.5	93.5	54	262	150	412	260	140	250
150	136	147.5	93.5	54	262	150	412	260	140	300
200	136	147.5	93.5	54	287	180	467	324	156	350
250	136	147.5	93.5	54	312	205	517	400	166	450
300	136	147.5	93.5	54	337	230	567	460	166	500

- 1) For order code for "Sensor option", option CG "Sensor extension neck": values + 110 mm
- 2) If using a display, order code for "Display; operation", option B: values + 28 mm
- 3) The length (L) is always the same, irrespective of the selected pressure rating.

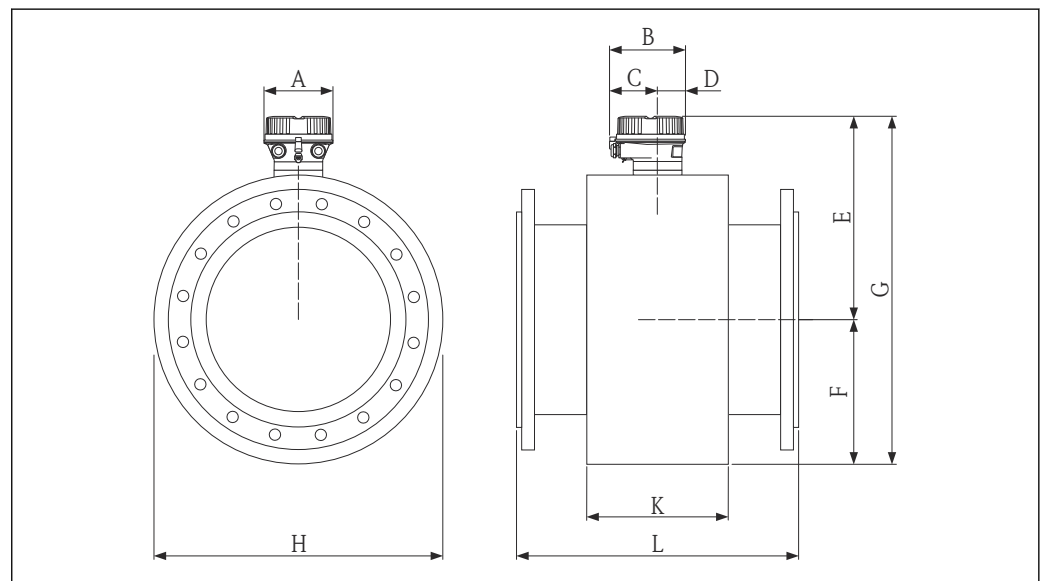

A0019493

DN [mm]	A [mm]	B [mm]	C [mm]	D [mm]	E ^{1) 2)} [mm]	F [mm]	G ^{1) 2)} [mm]	H [mm]	K [mm]	L ³⁾ [mm]
350	136	147.5	93.5	54	399	282	681	564	290	550
400	136	147.5	93.5	54	425	308	733	616	290	600
450	136	147.5	93.5	54	450	333	783	666	290	650
500	136	147.5	93.5	54	476	359	835	717	290	650
600	136	147.5	93.5	54	528	411	939	821	290	780

- 1) For order code for "Sensor option", option CG "Sensor extension neck": values + 110 mm
- 2) If using a display, order code for "Display; operation", option B: values + 28 mm
- 3) The length (L) is always the same, irrespective of the selected pressure rating.

Accessories

Ground disk for flange connection

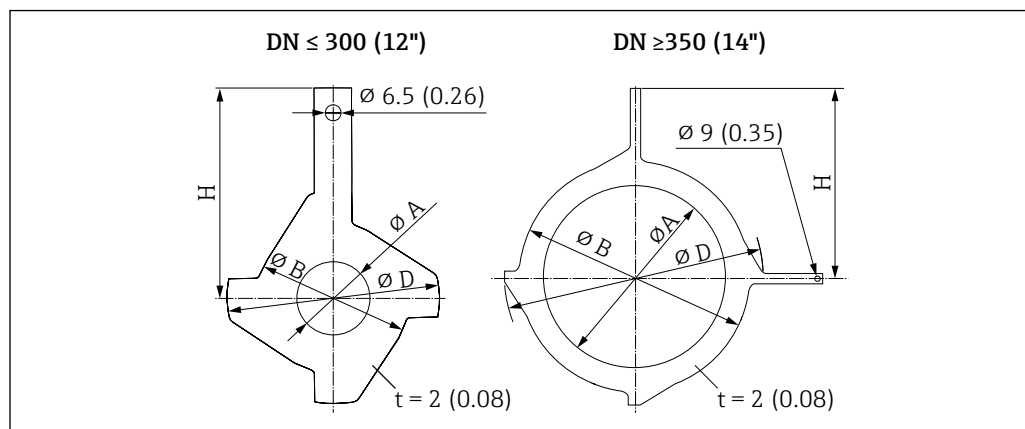

A0042090

DN ¹⁾ EN (DIN), JIS, AS ²⁾ [mm]	A PFA, PTFE [mm]	B [mm]	D [mm]	H [mm]
15	16	43	61.5	73
25	26	62	77.5	87.5
32	35	80	87.5	94.5
40	41	82	101	103
50	52	101	115.5	108
65	68	121	131.5	118
80	80	131	154.5	135
100	104	156	186.5	153
125	130	187	206.5	160
150	158	217	256	184
200	206	267	288	205
250	260	328	359	240
300 ³⁾	312	375	413	273
300 ⁴⁾	310	375	404	268
350 ³⁾	420	433	479	365
400 ³⁾	470	480	542	395
450 ³⁾	525	538	583	417
500 ³⁾	575	592	650	460
600 ³⁾	676	693	766	522

- 1) Ground disks DN 15 to 250 (½ to 10") can be used for all available flange standards/pressure ratings.
- 2) For flanges similar to AS, only DN 25 and DN 50 are available.
- 3) PN 10/16
- 4) PN 25, JIS 10K/20K

Dimensions in US units

Dimensions in US units

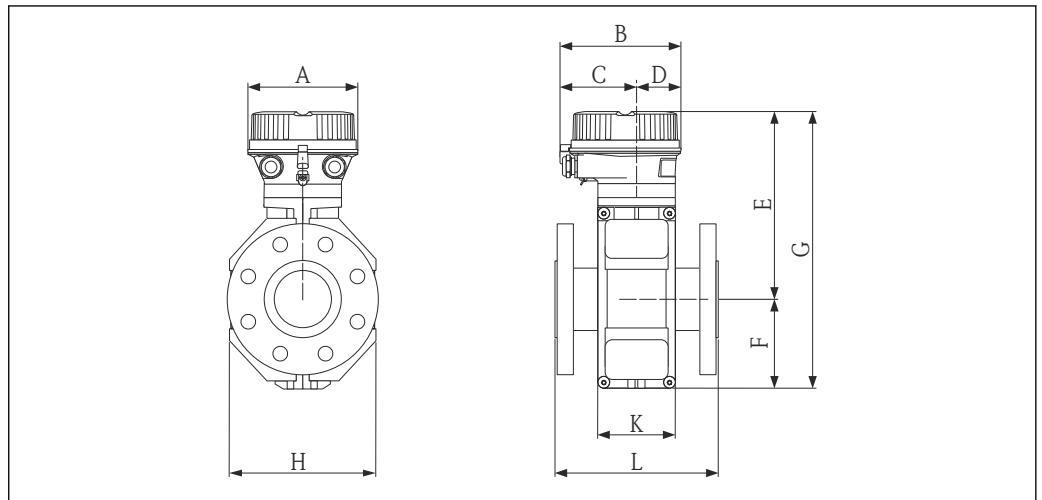

A0019491

Order code for "Housing", option A "Compact, coated aluminum"

DN	A	B	C	D	E ^{1) 2)}	F	G ^{1) 2)}	H	K	L ³⁾
[in]	[in]	[in]	[in]	[in]	[in]	[in]	[in]	[in]	[in]	[in]
½	5.35	5.81	3.68	2.13	7.76	3.31	11.1	4.72	3.70	7.87
1	5.35	5.81	3.68	2.13	7.76	3.31	11.1	4.72	3.70	7.87
1 ½	5.35	5.81	3.68	2.13	7.76	3.31	11.1	4.72	3.70	7.87
2	5.35	5.81	3.68	2.13	7.76	3.31	11.1	4.72	3.70	7.87
3	5.35	5.81	3.68	2.13	8.74	4.29	13.0	7.09	3.70	7.87
4	5.35	5.81	3.68	2.13	8.74	4.29	13.0	7.09	3.70	9.84
6	5.35	5.81	3.68	2.13	10.3	5.91	16.2	10.2	5.51	11.8
8	5.35	5.81	3.68	2.13	11.3	7.09	18.4	12.8	6.14	13.8
10	5.35	5.81	3.68	2.13	12.3	8.07	20.4	15.8	6.54	17.7
12	5.35	5.81	3.68	2.13	13.3	9.06	22.3	18.1	6.54	19.7

- 1) For order code for "Sensor option", option CG "Sensor extension neck": values + 4.33 in
- 2) If using a display, order code for "Display; operation", option B: values + 1.1 in
- 3) The length (L) is always the same, irrespective of the selected pressure rating.

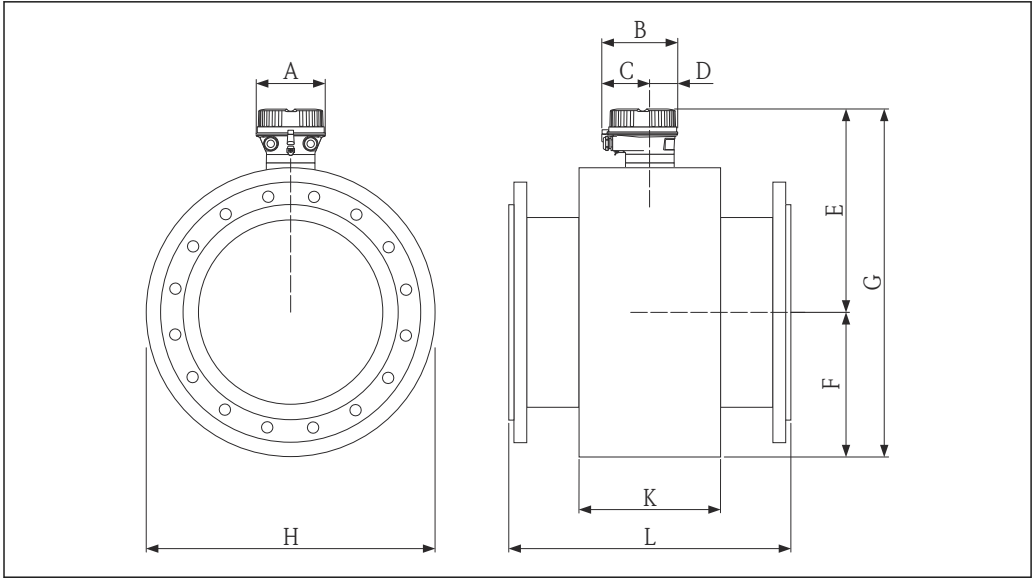

A0019493

DN [in]	A [in]	B [in]	C [in]	D [in]	E ^{1) 2)} [in]	F [in]	G ^{1) 2)} [in]	H [in]	K [in]	L ³⁾ [in]
14	5.35	5.81	3.68	2.13	15.7	11.1	26.8	22.2	11.4	21.7
16	5.35	5.81	3.68	2.13	16.7	12.1	28.9	24.3	11.4	23.6
18	5.35	5.81	3.68	2.13	17.7	13.1	30.8	26.2	11.4	25.6
20	5.35	5.81	3.68	2.13	18.7	14.1	32.9	28.2	11.4	25.6
24	5.35	5.81	3.68	2.13	20.8	16.2	37.0	32.3	11.4	30.7

- 1) For high temperature version: values + 4.33 in
- 2) If using a display, order code for "Display; operation", option B: values + 1.1 in
- 3) The length (L) is always the same, irrespective of the selected pressure rating.

Accessories

Ground disk for flange connection

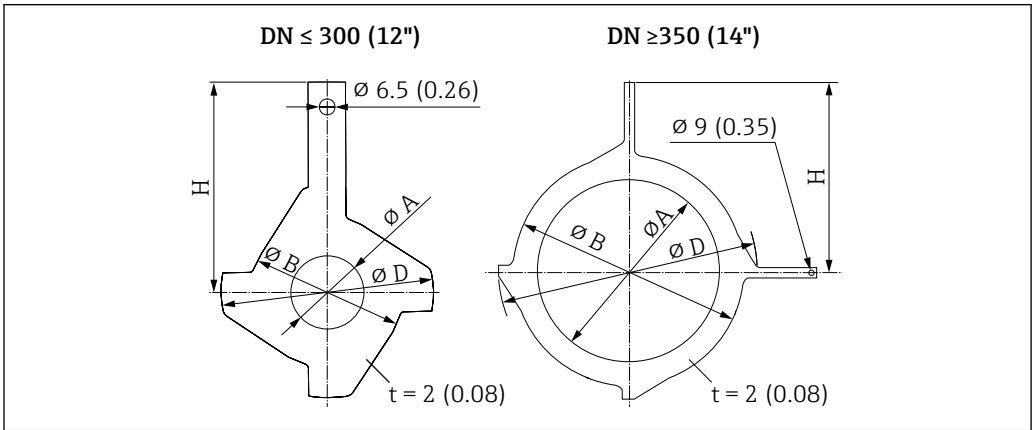

A0042090

DN ¹⁾ ASME [in]	A PFA, PTFE [in]	B [in]	D [in]	H [in]
½	0.63	1.69	2.42	2.87
1	1.02	2.44	3.05	3.44
1 ½	1.61	3.23	3.98	4.06
2	2.05	3.98	4.55	4.25
3	3.15	5.16	6.08	5.31
4	4.09	6.14	7.34	6.02
6	6.22	8.54	10.08	7.24
8	8.11	10.51	11.34	8.07
10	10.24	12.91	14.13	9.45
12	12.28	14.76	16.26	10.75
14	16.50	17.05	18.86	14.37
16	18.50	18.90	21.34	15.55
18	20.67	21.18	22.95	16.42
20	22.64	23.31	25.59	18.11
24	26.61	27.28	30.16	20.55

1) Ground disks can be used for all available pressure ratings.

Weight

All values (weight exclusive of packaging material) refer to devices with flanges of the standard pressure rating.

The weight may be lower than indicated depending on the pressure rating and design.

Weight specifications including transmitter: order code for "Housing", option A "Compact, aluminum coated".

Compact version

- Including the transmitter
- High-temperature version + 1.5 kg (3.31 lb)
- Weight specifications apply to standard pressure ratings and without packaging material.

Weight in SI units

Nominal diameter		EN (DIN), AS ¹⁾		ASME		JIS	
[mm]	[in]	Pressure rating	[kg]	Pressure rating	[kg]	Pressure rating	[kg]
15	½	PN 40	4.5	Class 150	4.5	10K	4.5
25	1	PN 40	5.3	Class 150	5.3	10K	5.3
32	–	PN 40	6	Class 150	–	10K	5.3
40	1 ½	PN 40	7.4	Class 150	7.4	10K	6.3
50	2	PN 40	8.6	Class 150	8.6	10K	7.3
65	–	PN 16	10	Class 150	–	10K	9.1
80	3	PN 16	12	Class 150	12	10K	10.5
100	4	PN 16	14	Class 150	14	10K	12.7
125	–	PN 16	19.5	Class 150	–	10K	19
150	6	PN 16	23.5	Class 150	23.5	10K	22.5
200	8	PN 10	43	Class 150	43	10K	39.9
250	10	PN 10	63	Class 150	73	10K	67.4

Nominal diameter		EN (DIN), AS ¹⁾		ASME		JIS	
[mm]	[in]	Pressure rating	[kg]	Pressure rating	[kg]	Pressure rating	[kg]
300	12	PN 10	68	Class 150	108	10K	70.3
350	14	PN 10	103	Class 150	173	10K	79
400	16	PN 10	118	Class 150	203	10K	100
450	18	PN 10	159	Class 150	253	10K	128
500	20	PN 10	154	Class 150	283	10K	142
600	24	PN 10	206	Class 150	403	10K	188

1) For flanges according to AS, only DN 25 and 50 are available.

Weight in US units

Nominal diameter		ASME	
[mm]	[in]	Pressure rating	[lbs]
15	½	Class 150	9.92
25	1	Class 150	11.7
40	1 ½	Class 150	16.3
50	2	Class 150	19.0
80	3	Class 150	26.5
100	4	Class 150	30.9
150	6	Class 150	51.8
200	8	Class 150	94.8
250	10	Class 150	161.0
300	12	Class 150	238.1
350	14	Class 150	381.5
400	16	Class 150	447.6
450	18	Class 150	557.9
500	20	Class 150	624.0
600	24	Class 150	888.6

Measuring tube specification

Nominal diameter		Pressure rating					Process connection internal diameter			
		EN (DIN)	ASME	AS 2129	AS 4087	JIS	PFA		PTFE	
[mm]	[in]	[bar]	[psi]	[bar]	[bar]	[bar]	[mm]	[in]	[mm]	[in]
15	½	PN 40	Class 150	-	-	20K	-	-	15	0.59
25	1	PN 40	Class 150	Table E	-	20K	23	0.91	26	1.02
32	-	PN 40	-	-	-	20K	32	1.26	35	1.38
40	1 ½	PN 40	Class 150	-	-	20K	36	1.42	41	1.61
50	2	PN 40	Class 150	Table E	PN 16	10K	48	1.89	52	2.05
65	-	PN 16	-	-	-	10K	63	2.48	67	2.64
80	3	PN 16	Class 150	-	-	10K	75	2.95	80	3.15
100	4	PN 16	Class 150	-	-	10K	101	3.98	104	4.09
125	-	PN 16	-	-	-	10K	126	4.96	129	5.08
150	6	PN 16	Class 150	-	-	10K	154	6.06	156	6.14

Nominal diameter		Pressure rating					Process connection internal diameter			
		EN (DIN)	ASME	AS 2129	AS 4087	JIS	PFA		PTFE	
[mm]	[in]	[bar]	[psi]	[bar]	[bar]	[bar]	[mm]	[in]	[mm]	[in]
200	8	PN 10	Class 150	-	-	10K	201	7.91	202	7.95
250	10	PN 10	Class 150	-	-	10K	-	-	256	10.1
300	12	PN 10	Class 150	-	-	10K	-	-	306	12.0
350	14	PN 10	Class 150	-	-	10K	-	-	337	13.3
400	16	PN 10	Class 150	-	-	10K	-	-	387	15.2
450	18	PN 10	Class 150	-	-	10K	-	-	432	17.0
500	20	PN 10	Class 150	-	-	10K	-	-	487	19.2
600	24	PN 10	Class 150	-	-	10K	-	-	593	23.3

Materials

Transmitter housing

- Order code for "Housing", option A "Compact, aluminum coated":
Aluminum, AlSi10Mg, coated
- Window material for optional local display (→ 49):
For order code for "Housing", option A: glass

Cable entries/cable glands

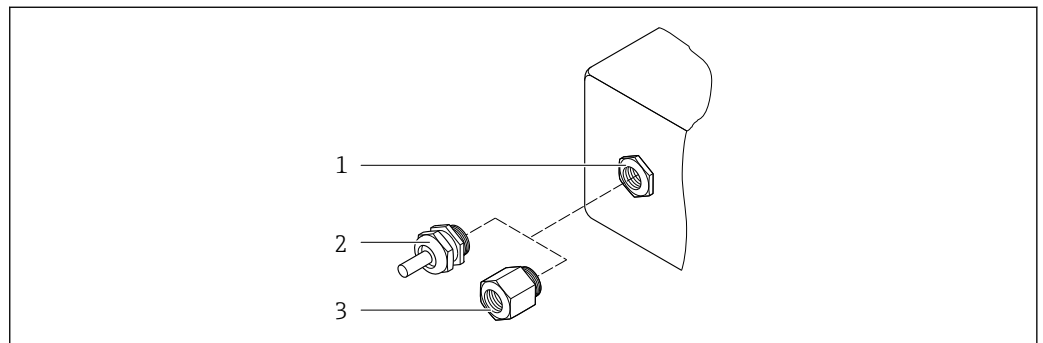

12 Possible cable entries/cable glands

- 1 Female thread M20 × 1.5
- 2 Cable gland M20 × 1.5
- 3 Adapter for cable entry with female thread G ½" or NPT ½"

Order code for "Housing", option A "Compact, aluminum, coated"

The various cable entries are suitable for hazardous and non-hazardous areas.

Cable entry/cable gland	Material
Cable gland M20 × 1.5	Nickel-plated brass
Adapter for cable entry with internal thread G ½"	
Adapter for cable entry with internal thread NPT ½"	

Device plug

Electrical connection	Material
Plug M12x1	<ul style="list-style-type: none"> Socket: Stainless steel, 1.4404 (316L) Contact housing: Polyamide Contacts: Gold-plated brass

Sensor housing

- DN 15 to 300 (½ to 12")
Aluminum half-shell housing, aluminum, AlSi10Mg, coated
- DN 350 to 600 (14 to 24")
Fully welded carbon steel housing with protective varnish

Measuring tubes

Stainless steel, 1.4301/304/1.4306/304L

For flanges made of carbon with Al/Zn protective coating (DN 15 to 300 (½ to 12")) or protective varnish (DN 350 to 600 (14 to 24"))

Liner

- PFA
- PTFE

Process connections

EN 1092-1 (DIN 2501)

Stainless steel, 1.4571; carbon steel, E250C¹⁾/S235JRG2/P245GH

ASME B16.5

Stainless steel, F316L; carbon steel, A105¹⁾

JIS B2220

Stainless steel, F316L; carbon steel, A105/A350 LF2¹⁾

AS 2129 Table E

- DN 25 (1"): carbon steel, A105/S235JRG2
- DN 40 (1 ½"): carbon steel, A105/S275JR

AS 4087 PN 16

Carbon steel, A105/S275JR

Electrodes

Stainless steel, 1.4435 (F316L); Alloy C22, 2.4602 (UNS N06022); platinum; tantalum; titanium

Seals

As per DIN EN 1514-1, form IBC

Accessories*Ground disks*

- Stainless steel, 1.4435 (316L)
- Alloy C22, 2.4602 (UNS N06022)
- Titanium

Fitted electrodes

Measuring electrode, reference electrode and empty pipe detection electrode:

- 1.4435 (316L)
- Alloy C22, 2.4602 (UNS N06022)
- Tantalum
- Titanium
- Platinum

Optional: only platinum or tantalum measuring electrode

Process connections

- EN 1092-1 (DIN 2501)
- ASME B16.5
- JIS B2220
- AS 2129 Table E
- AS 4087 PN 16



For information on the different materials used in the process connections → 48

1) DN 15 to 300 (½ to 12") with Al/Zn protective varnish; DN 350 to 600 (14 to 24") with protective varnish

Surface roughness	<p>Stainless steel electrodes, 1.4435 (F316L); Alloy C22, 2.4602 (UNS N06022); platinum; tantalum; titanium: ≤ 0.3 to $0.5 \mu\text{m}$ (11.8 to $19.7 \mu\text{in}$) (All data refer to parts in contact with the medium)</p> <p>Liner with PFA: $\leq 0.4 \mu\text{m}$ ($15.7 \mu\text{in}$) (All data refer to parts in contact with the medium)</p>
--------------------------	---

Operability

Operating concept	<p>Operator-oriented menu structure for user-specific tasks</p> <ul style="list-style-type: none"> ■ Commissioning ■ Operation ■ Diagnostics ■ Expert level <p>Quick and safe commissioning</p> <ul style="list-style-type: none"> ■ Individual menus for applications ■ Menu guidance with brief explanations of the individual parameter functions <p>Reliable operation</p> <ul style="list-style-type: none"> ■ Operation in the following languages: <ul style="list-style-type: none"> ■ Via "FieldCare", "DeviceCare" operating tool: English, German, French, Spanish, Italian, Chinese, Japanese ■ Via integrated Web browser (only available for device versions with HART, PROFIBUS DP, PROFINET and EtherNet/IP): English, German, French, Spanish, Italian, Dutch, Portuguese, Polish, Russian, Turkish, Chinese, Japanese, Bahasa (Indonesian), Vietnamese, Czech, Swedish, Korean ■ Uniform operating philosophy applied to operating tools and Web browser ■ If replacing the electronic module, transfer the device configuration via the plug-in memory (HistoROM DAT) which contains the process and measuring device data and the event logbook. No need to reconfigure. For devices with Modbus RS485, the data recovery function is implemented without the plug-in memory (HistoROM DAT). <p>Efficient diagnostics increase measurement availability</p> <ul style="list-style-type: none"> ■ Troubleshooting measures can be called up via the operating tools and web browser ■ Diverse simulation options ■ Status indicated by several light emitting diodes (LEDs) on the electronic module in the housing compartment
Local display	<p> A local display is only available for device versions with the following communication protocols: HART, PROFIBUS-DP, PROFINET, EtherNet/IP</p> <p>The local display is only available with the following device order code: Order code for "Display; operation", option B: 4-line; illuminated, via communication</p> <p>Display element</p> <ul style="list-style-type: none"> ■ 4-line liquid crystal display with 16 characters per line. ■ White background lighting; switches to red in event of device errors. ■ Format for displaying measured variables and status variables can be individually configured. ■ Permitted ambient temperature for the display: -20 to $+60 \text{ }^\circ\text{C}$ (-4 to $+140 \text{ }^\circ\text{F}$). The readability of the display may be impaired at temperatures outside the temperature range.
Remote operation	<p>Via HART protocol</p> <p>This communication interface is available in device versions with a HART output.</p>

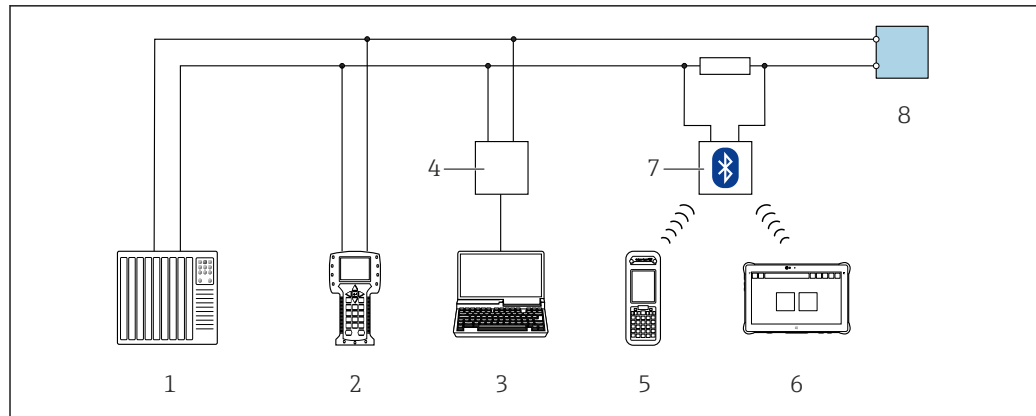

A0028747

13 Options for remote operation via HART protocol

- 1 Control system (e.g. PLC)
- 2 Field Communicator 475
- 3 Computer with operating tool (e.g. FieldCare, AMS Device Manager, SIMATIC PDM)
- 4 Commubox FXA195 (USB)
- 5 Field Xpert SFX350 or SFX370
- 6 Field Xpert SMT70
- 7 VIATOR Bluetooth modem with connecting cable
- 8 Transmitter

Via PROFIBUS DP network

This communication interface is available in device versions with PROFIBUS DP.

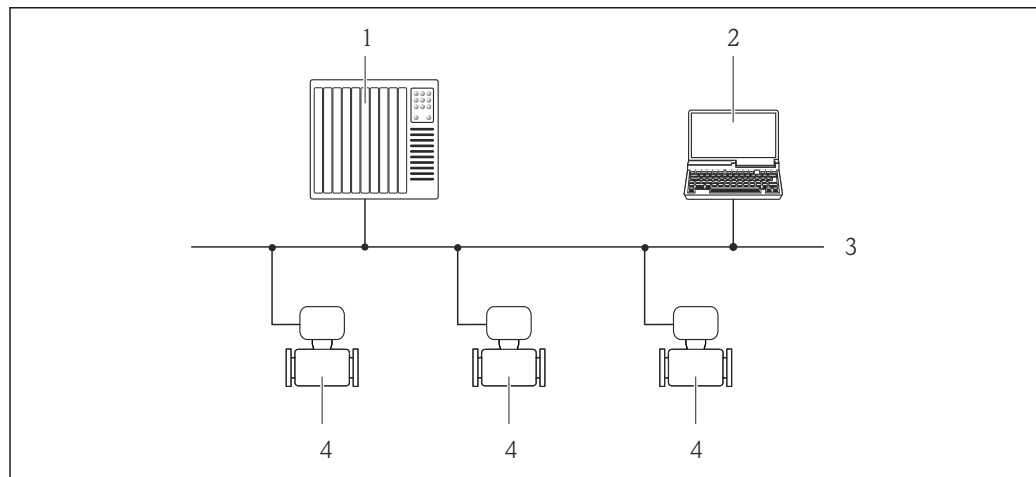

A0020903

14 Options for remote operation via PROFIBUS DP network

- 1 Automation system
- 2 Computer with PROFIBUS network card
- 3 PROFIBUS DP network
- 4 Measuring device

Via EtherNet/IP network

This communication interface is available in device versions with EtherNet/IP.

Star topology

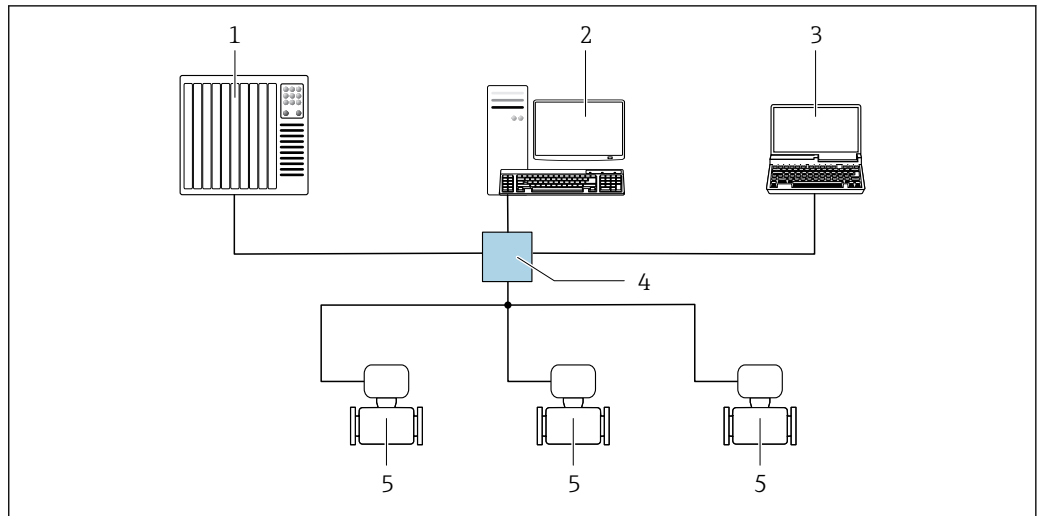

A0032078

15 Options for remote operation via EtherNet/IP network: star topology

- 1 Automation system, e.g. "RSLogix" (Rockwell Automation)
- 2 Workstation for measuring device operation: with Custom Add-On Profile for "RSLogix 5000" (Rockwell Automation) or with Electronic Data Sheet (EDS)
- 3 Computer with Web browser (e.g. Internet Explorer) for accessing the integrated Web server or computer with operating tool (e.g. FieldCare, DeviceCare) with COM DTM "CDI Communication TCP/IP"
- 4 Standard Ethernet switch, e.g. Scalance X204 (Siemens)
- 5 Measuring device

Via PROFINET network

This communication interface is available in device versions with PROFINET.

Star topology

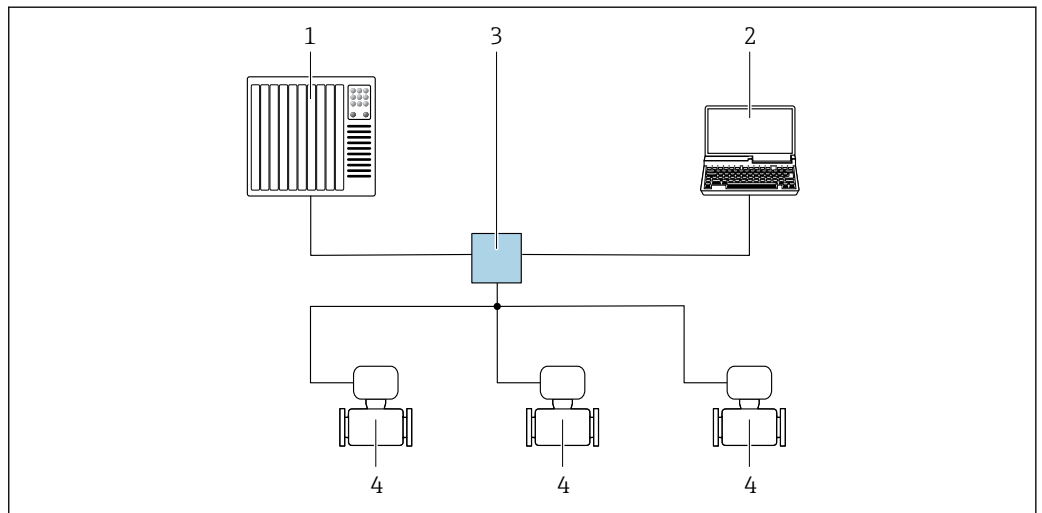

A0026545

16 Options for remote operation via PROFINET network: star topology

- 1 Automation system, e.g. Simatic S7 (Siemens)
- 2 Computer with Web browser (e.g. Internet Explorer) for accessing the integrated Web server or computer with operating tool (e.g. FieldCare, DeviceCare, SIMATIC PDM) with COM DTM "CDI Communication TCP/IP"
- 3 Standard Ethernet switch, e.g. Scalance X204 (Siemens)
- 4 Measuring device

Service interface

Via service interface (CDI-RJ45)

This communication interface is present in the following device version:

- Order code for "Output", option **B**: 4-20 mA HART, pulse/frequency/switch output
- Order code for "Output", option **L**: PROFIBUS DP
- Order code for "Output", option **N**: EtherNet/IP
- Order code for "Output", option **R**: PROFINET

HART

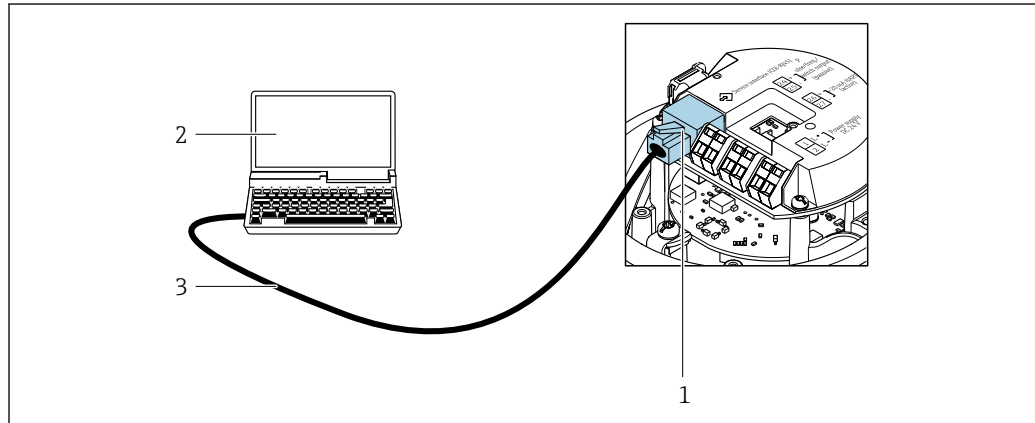

17 Connection for the order code for "Output", option B: 4-20 mA HART, pulse/frequency/switch output

- 1 Service interface (CDI-RJ45) of the measuring device with access to the integrated web server
- 2 Computer with web browser (e.g. Internet Explorer) for accessing the integrated web server or with "FieldCare" operating tool with COM DTM "CDI Communication TCP/IP"
- 3 Standard Ethernet connecting cable with RJ45 plug

PROFIBUS DP

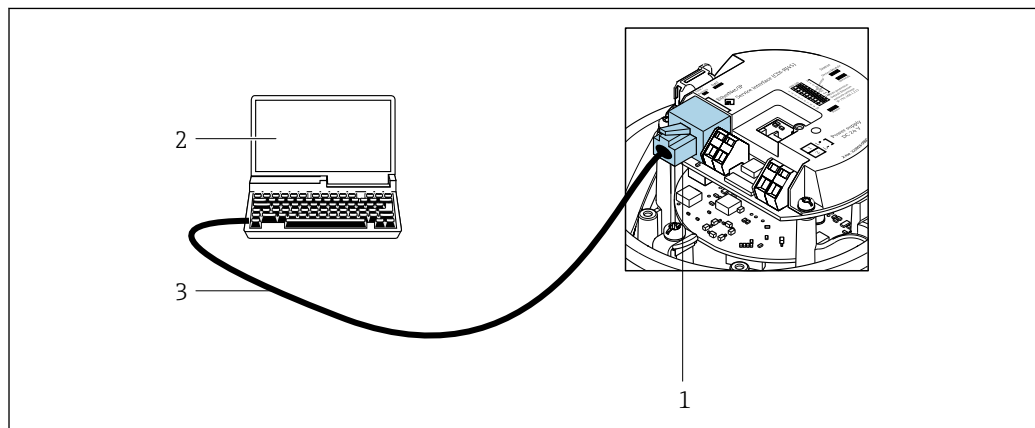

18 Connection for order code for "Output", option L: PROFIBUS DP

- 1 Service interface (CDI-RJ45) of the measuring device with access to the integrated web server
- 2 Computer with web browser (e.g. Internet Explorer) for accessing the integrated web server or with "FieldCare" operating tool with COM DTM "CDI Communication TCP/IP"
- 3 Standard Ethernet connecting cable with RJ45 plug

EtherNet/IP

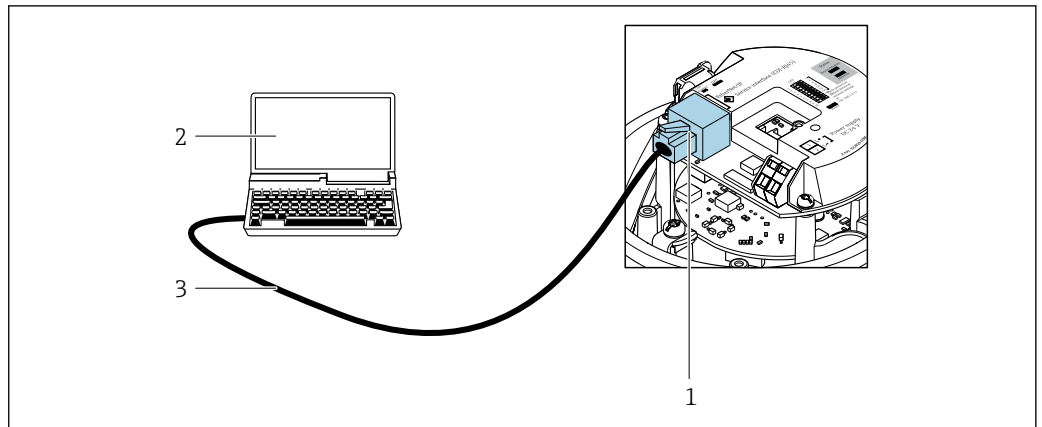

19 Connection for order code for "Output", option N: EtherNet/IP

- 1 Service interface (CDI-RJ45) and EtherNet/IP interface of the measuring device with access to the integrated web server
- 2 Computer with web browser (e.g. Internet Explorer) for accessing the integrated web server or with "FieldCare" operating tool with COM DTM "CDI Communication TCP/IP"
- 3 Standard Ethernet connecting cable with RJ45 plug

PROFINET

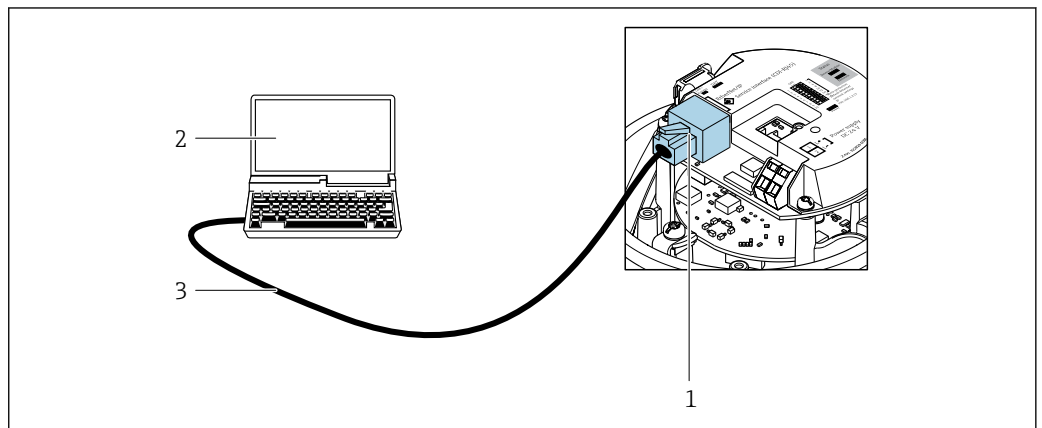

20 Connection for order code for "Output", option R: PROFINET

- 1 Service interface (CDI-RJ45) and PROFINET interface of the measuring device with access to the integrated web server
- 2 Computer with web browser (e.g. Internet Explorer) for accessing the integrated web server or with "FieldCare" operating tool with COM DTM "CDI Communication TCP/IP"
- 3 Standard Ethernet connecting cable with RJ45 plug

Via service interface (CDI)

This communication interface is present in the following device version:
Order code for "Output", option **M**: Modbus RS485

Modbus RS485

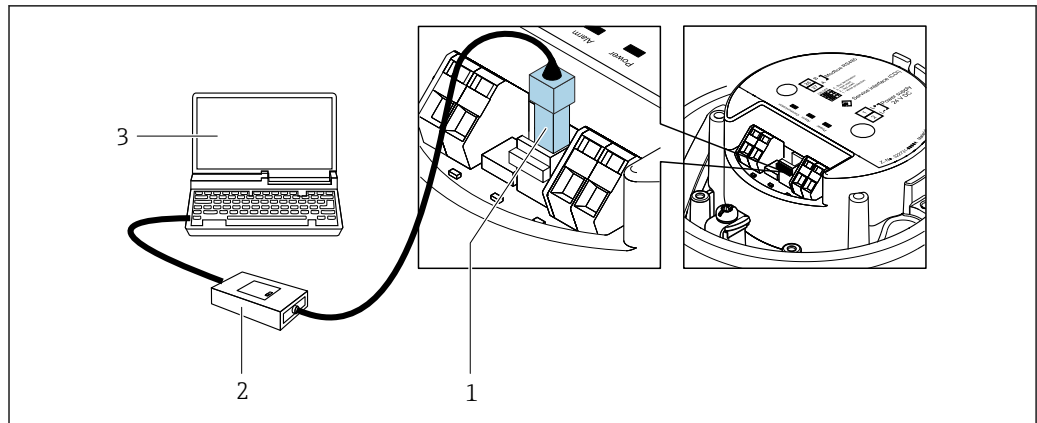

A0030216

- 1 Service interface (CDI) of measuring device
- 2 Commubox FXA291
- 3 Computer with "FieldCare" operating tool with COM DTM "CDI Communication FXA291"

Certificates and approvals

Current certificates and approvals for the product are available at www.endress.com on the relevant product page:

1. Select the product using the filters and search field.
2. Open the product page.
3. Select **Downloads**.

CE mark

The device meets the legal requirements of the applicable EU Directives. These are listed in the corresponding EU Declaration of Conformity along with the standards applied.

Endress+Hauser confirms successful testing of the device by affixing to it the CE mark.

UKCA marking

The device meets the legal requirements of the applicable UK regulations (Statutory Instruments). These are listed in the UKCA Declaration of Conformity along with the designated standards. By selecting the order option for UKCA marking, Endress+Hauser confirms a successful evaluation and testing of the device by affixing the UKCA mark.

Contact address Endress+Hauser UK:

Endress+Hauser Ltd.
Floats Road
Manchester M23 9NF
United Kingdom
www.uk.endress.com

RCM marking

The measuring system meets the EMC requirements of the "Australian Communications and Media Authority (ACMA)".

Ex approval

The measuring device is certified for use in hazardous areas and the relevant safety instructions are provided in the separate "Safety Instructions" (XA) document. Reference is made to this document on the nameplate.

-  The separate Ex documentation (XA) containing all the relevant explosion protection data is available from your Endress+Hauser sales center.

ATEX, IECEx

Currently, the following versions for use in hazardous areas are available:

Ex nA

Category	Type of protection
II3G	Ex nA IIC T6-T1 Gc

cCSAus

Currently, the following versions for use in hazardous areas are available:

NI

Category	Type of protection
Class I Division 2 Groups ABCD	NI (Non-incendive version), NIFW parameter ¹⁾

1) Entity and NIFW parameter according to Control Drawings

HART certification

HART interface

The measuring device is certified and registered by the FieldComm Group. The measuring system meets all the requirements of the following specifications:

- Certified according to HART 7
- The device can also be operated with certified devices of other manufacturers (interoperability)

Certification PROFIBUS

PROFIBUS interface

The measuring device is certified and registered by the PNO (PROFIBUS Nutzerorganisation e.V./ PROFIBUS User Organization). The measuring system meets all the requirements of the following specifications:

- Certified according to PA Profile 3.02
- The device can also be operated with certified devices of other manufacturers (interoperability)

EtherNet/IP certification

The measuring device is certified and registered by the ODVA (Open Device Vendor Association). The measuring system meets all the requirements of the following specifications:

- Certified in accordance with the ODVA Conformance Test
- EtherNet/IP Performance Test
- EtherNet/IP PlugFest compliance
- The device can also be operated with certified devices of other manufacturers (interoperability)

Certification PROFINET

PROFINET interface

The measuring device is certified and registered by the PNO (PROFIBUS Nutzerorganisation e.V. / PROFIBUS User Organization). The measuring system meets all the requirements of the following specifications:

- Certified according to:
 - Test specification for PROFINET devices
 - PROFINET Security Level 1– Netload Class 2 0 Mbps
- The device can also be operated with certified devices of other manufacturers (interoperability)
- The device supports PROFINET S2 system redundancy.

Pressure Equipment Directive

The measuring devices can be ordered with or without PED or PESR. If a device with PED or PESR is required, this must be ordered explicitly. For devices with nominal diameters less than or equal to DN 25 (1"), this is neither possible nor necessary. A UK order option must be selected for PESR under the order code for "Approvals".

- With the marking
 - a) PED/G1/x (x = category) or
 - b) PESR/G1/x (x = category)
 on the sensor nameplate, Endress+Hauser confirms compliance with the "Essential Safety Requirements"
 - a) specified in Annex I of the Pressure Equipment Directive 2014/68/EU or
 - b) Schedule 2 of Statutory Instruments 2016 No. 1105.
- Devices bearing this marking (PED or PESR) are suitable for the following types of medium: Media in Group 1 and 2 with a vapor pressure greater than, or smaller and equal to 0.5 bar (7.3 psi)
- Devices not bearing this marking (without PED or PESR) are designed and manufactured according to sound engineering practice. They meet the requirements of
 - a) Art. 4 Para. 3 of the Pressure Equipment Directive 2014/68/EU or
 - b) Part 1, Para. 8 of Statutory Instruments 2016 No. 1105.
 The scope of application is indicated
 - a) in diagrams 6 to 9 in Annex II of the Pressure Equipment Directive 2014/68/EU or
 - b) Schedule 3, Para. 2 of Statutory Instruments 2016 No. 1105.

External standards and guidelines

- EN 60529
Degrees of protection provided by enclosure (IP code)
- EN 61010-1
Safety requirements for electrical equipment for measurement, control and laboratory use - general requirements
- IEC/EN 61326-2-3
Emission in accordance with Class A requirements. Electromagnetic compatibility (EMC requirements).
- NAMUR NE 21
Electromagnetic compatibility (EMC) of industrial process and laboratory control equipment
- NAMUR NE 32
Data retention in the event of a power failure in field and control instruments with microprocessors
- NAMUR NE 43
Standardization of the signal level for the breakdown information of digital transmitters with analog output signal.
- NAMUR NE 53
Software of field devices and signal-processing devices with digital electronics
- NAMUR NE 105
Specifications for integrating fieldbus devices in engineering tools for field devices
- NAMUR NE 107
Self-monitoring and diagnosis of field devices
- NAMUR NE 131
Requirements for field devices for standard applications
- ETSI EN 300 328
Guidelines for 2.4 GHz radio components.
- EN 301489
Electromagnetic compatibility and radio spectrum matters (ERM).

Ordering information

Detailed ordering information is available from the following sources:

- In the Product Configurator on the Endress+Hauser website: www.endress.com -> Click "Corporate" -> Select your country -> Click "Products" -> Select the product using the filters and search field -> Open product page -> The "Configure" button to the right of the product image opens the Product Configurator.
- From your Endress+Hauser Sales Center: www.addresses.endress.com



Product Configurator - the tool for individual product configuration

- Up-to-the-minute configuration data
 - Depending on the device: direct input of information specific to the measuring point, such as the measuring range or operating language
 - Automatic verification of exclusion criteria
 - Automatic creation of the order code and its breakdown in PDF or Excel output format
 - Ability to order directly in the Endress+Hauser Online Shop

Application packages

Many different application packages are available to enhance the functionality of the device. Such packages might be needed to address safety aspects or specific application requirements.

The application packages can be ordered with the device or subsequently from Endress+Hauser. Detailed information on the order code in question is available from your local Endress+Hauser sales center or on the product page of the Endress+Hauser website: www.endress.com.

Cleaning

Order code for "Application package", option EC "ECC electrode cleaning "

The electrode cleaning circuit (ECC) function has been developed to have a solution for applications where magnetite (Fe₃O₄) deposits frequently occur (e.g. hot water). Since magnetite is highly conductive this build up leads to measuring errors and ultimately to the loss of signal. The application package is designed to avoid build-up of very conductive matter and thin layers (typical of magnetite).



For detailed information, see the Operating Instructions for the device.

Heartbeat Technology

Order code for "Application package", option EB "Heartbeat Verification + Monitoring"

Heartbeat Verification

Meets the requirement for traceable verification to DIN ISO 9001:2008 Chapter 7.6 a) "Control of monitoring and measuring equipment".

- Functional testing in the installed state without interrupting the process.
- Traceable verification results on request, including a report.
- Simple testing process via local operation or other operating interfaces.
- Clear measuring point assessment (pass/fail) with high test coverage within the framework of manufacturer specifications.
- Extension of calibration intervals according to operator's risk assessment.

Heartbeat Monitoring

Continuously supplies data, which are characteristic of the measuring principle, to an external condition monitoring system for the purpose of preventive maintenance or process analysis. These data enable the operator to:

- Draw conclusions - using these data and other information - about the impact process influences (e.g. buildup, interference from the magnetic field) have on the measuring performance over time.
- Schedule servicing in time.
- Monitor the process or product quality .



For detailed information, see the Special Documentation for the device.

Accessories

Various accessories, which can be ordered with the device or subsequently from Endress+Hauser, are available for the device. Detailed information on the order code in question is available from your local Endress+Hauser sales center or on the product page of the Endress+Hauser website: www.endress.com.

Device-specific accessories





For the transmitter

Accessories	Description
Ground cable	Set, consisting of two ground cables for potential equalization.



For the sensor

Accessories	Description
Ground disks	Are used to ground the medium in lined measuring tubes to ensure proper measurement.  For details, see Installation Instructions EA00070D



Communication-specific accessories

Accessories	Description
Commubox FXA195 HART	For intrinsically safe HART communication with FieldCare via the USB port.  Technical Information TI00404F
Commubox FXA291	Connects Endress+Hauser field devices with a CDI interface (= Endress+Hauser Common Data Interface) and the USB port of a computer or laptop.  Technical Information TI00405C
HART loop converter HMX50	Is used to evaluate and convert dynamic HART process variables to analog current signals or limit values.  <ul style="list-style-type: none"> ▪ Technical Information TI00429F ▪ Operating Instructions BA00371F
Wireless HART adapter SWA70	Is used for the wireless connection of field devices. The WirelessHART adapter can be easily integrated into field devices and existing infrastructures, offers data protection and transmission safety and can be operated in parallel with other wireless networks with minimum cabling complexity.  Operating Instructions BA00061S

Service-specific accessories

Accessories	Description
Applicator	Software for selecting and sizing Endress+Hauser measuring instruments: <ul style="list-style-type: none"> ▪ Choice of measuring instruments for industrial requirements ▪ Calculation of all the necessary data for identifying the optimum flowmeter: e.g. nominal diameter, pressure loss, flow velocity and measurement accuracy. ▪ Graphic display of the calculation results ▪ Determination of the partial order code, administration, documentation and access to all project-related data and parameters over the entire life cycle of a project. Applicator is available: Via the Internet: https://portal.endress.com/webapp/applicator
Netilion	IloT ecosystem: Unlock knowledge With the Netilion IloT ecosystem, Endress+Hauser allows you to optimize your plant performance, digitize workflows, share knowledge, and enhance collaboration. Drawing upon decades of experience in process automation, Endress+Hauser offers the process industry an IloT ecosystem designed to effortlessly extract insights from data. These insights allow process optimization, leading to increased plant availability, efficiency, and reliability - ultimately resulting in a more profitable plant. www.netilion.endress.com
FieldCare	FDT-based plant asset management tool from Endress+Hauser. It can configure all intelligent field units in your system and helps you manage them. By using the status information, it is also a simple but effective way of checking their status and condition.  Operating Instructions BA00027S and BA00059S
DeviceCare	Tool to connect and configure Endress+Hauser field devices.  Innovation brochure IN01047S

System components

Accessories	Description
Memograph M graphic data manager	The Memograph M graphic data manager provides information on all the relevant measured variables. Measured values are recorded correctly, limit values are monitored and measuring points analyzed. The data are stored in the 256 MB internal memory and also on a SD card or USB stick.  <ul style="list-style-type: none"> ▪ Technical Information TI00133R ▪ Operating Instructions BA00247R
iTEMP	The temperature transmitters can be used in all applications and are suitable for the measurement of gases, steam and liquids. They can be used to read in the medium temperature.  "Fields of Activity" document FA00006T

Documentation

-  For an overview of the scope of the associated Technical Documentation, refer to the following:
- *Device Viewer* (www.endress.com/deviceviewer): Enter the serial number from the nameplate
 - *Endress+Hauser Operations app*: Enter serial number from nameplate or scan matrix code on nameplate.

Standard documentation

-  Supplementary information on the semi-standard options is available in the relevant Special Documentation in the TSP database.

Brief Operating Instructions

-  Brief Operating Instructions containing all the important information for standard commissioning is enclosed with the device.

Operating Instructions

Measuring device	Documentation code				
	HART	PROFIBUS DP	Modbus RS485	EtherNet/IP	PROFINET
Promag P 100	BA01172D	BA01238D	BA01176D	BA01174D	BA01422D

Description of device parameters

Measuring device	Documentation code				
	HART	PROFIBUS DP	Modbus RS485	EtherNet/IP	PROFINET
Promag 100	GP01038D	GP01039D	GP01040D	GP01041D	GP01042D

Supplementary device-dependent documentation

Safety instructions

Contents	Documentation code
ATEX/IECEX Ex nA	XA01090D

Special Documentation

Contents	Documentation code
Information on the Pressure Equipment Directive	SD01056D
Modbus RS485 register information	SD01148D
Heartbeat Technology	SD01149D

Installation instructions

Contents	Note
Installation instructions for spare part sets and accessories	Documentation code: specified for each individual accessory →  57.

Registered trademarks**HART®**

Registered trademark of the FieldComm Group, Austin, Texas, USA

PROFIBUS®

Registered trademark of the PROFIBUS Nutzerorganisation e.V. (PROFIBUS User Organization), Karlsruhe, Germany

Modbus®

Registered trademark of SCHNEIDER AUTOMATION, INC.

EtherNet/IP™

Trademark of ODVA, Inc.

PROFINET®

Registered trademark of the PROFIBUS Nutzerorganisation e.V. (PROFIBUS User Organization), Karlsruhe, Germany



71689992

www.addresses.endress.com