

# General Specifications

## EJA510E and EJA530E Absolute and Gauge Pressure Transmitter



GS 01C31F01-01EN

[Style: S2]

The high performance absolute and gauge pressure transmitter EJA510E and EJA530E feature single crystal silicon resonant sensor and are suitable to measure liquid, gas, or steam pressure. EJA510E and EJA530E output a 4 to 20 mA DC signal corresponding to the measured pressure. It also features quick response, remote setup and monitoring via BRAIN or HART communications and self-diagnostics. FOUNDATION Fieldbus, PROFIBUS PA and 1 to 5 V DC with HART (Low Power) protocol types are also available.

EJA-E series models in their standard configuration, with the exception of the Fieldbus, PROFIBUS and Low Power types, are certified as complying with SIL 2 for safety requirement.



### ■ STANDARD SPECIFICATIONS

Refer to GS 01C31T02-01EN for Fieldbus communication type and GS 01C31T04-01EN for PROFIBUS PA communication type for the items marked with "∅."

#### □ SPAN AND RANGE LIMITS

(For EJA510E, values are in absolute pressure and lower range limits are 0.)

Measurement Span/Range	MPa	psi (/D1)	bar (/D3)	kgf/cm <sup>2</sup> (/D4)	
A	Span	10 to 200 kPa	1.45 to 29	0.1 to 2	0.1 to 2
	Range	-100 to 200 kPa	-14.5 to 29	-1 to 2	-1 to 2
B	Span	0.02 to 2	2.9 to 290	0.2 to 20	0.2 to 20
	Range	-0.1 to 2	-14.5 to 290	-1 to 20	-1 to 20
C	Span	0.1 to 10	14.5 to 1450	1 to 100	1 to 100
	Range	-0.1 to 10	-14.5 to 1450	-1 to 100	-1 to 100
D	Span *	0.5 to 50	72.5 to 7200	5 to 500	5 to 500
	Range *	-0.1 to 50	-14.5 to 7200	-1 to 500	-1 to 500

\*: Maximum value shall be 70 MPa, 10150 psi, 700 bar or 700 kgf/cm<sup>2</sup> respectively when /HG is specified.

#### □ PERFORMANCE SPECIFICATIONS

Zero-based calibrated span, linear output, wetted parts material code 'S' and silicone oil, unless otherwise mentioned.  
For Fieldbus and PROFIBUS PA communication types, use calibrated range instead of span in the following specifications.

#### Specification Conformance

EJA-E series ensures specification conformance to at least  $\pm 3\sigma$ .

#### Reference Accuracy of Calibrated Span

(includes the effects of terminal-based linearity, hysteresis, and repeatability)

Measurement span	Reference Accuracy	
	Span $\geq$ X	Span<X
A	$\pm 0.055\%$ of Span	$\pm(0.0055 \text{ URL/ span})\%$ of Span
B		
C		
D		

#### [When /HAC is specified]

Measurement span	Reference Accuracy	
	Span $\geq$ X	Span<X
A	$\pm 0.04\%$ of Span	$\pm(0.004 \text{ URL/ span})\%$ of Span
B		$\pm(0.005+0.0035 \text{ URL/ span})\%$ of Span
C		
D		$\pm(0.0064 * 50 \text{ MPa/ span})\%$ of Span

Measurement span	A	B	C	D
X	20 kPa (2.9 psi)	0.2 MPa (29 psi)	1 MPa (145 psi)	8 MPa (1160 psi)
URL (Upper range limit)	200 kPa (29 psi)	2 MPa (290 psi)	10 MPa (1450 psi)	50 MPa (7200 psi)

**Ambient Temperature Effects per 28°C (50°F) Change**

±(0.15% of Span + 0.15% of URL) for A, B and C capsule.  
 ±(0.15% of Span + 0.15% of 50 MPa) for D capsule.

**Stability (All normal operating condition)**

EJA530E: ±0.1% of URL for 10 years  
 EJA510E: ±0.2% of URL for 10 years

**Power Supply Effects**

±0.005 % per Volt (from 21.6 to 32 V DC, 350Ω)

**Vibration Effects**Amplifier housing code 1 and 3:

Less than 0.1% of URL when tested per the requirements of IEC60770-1 field or pipeline with high vibration level (10-60 Hz, 0.21 mm displacement/60-2000 Hz 3 g)

Amplifier housing code 2:

Less than ±0.1% of URL when tested per the requirements of IEC60770-1 field with general application or pipeline with low vibration level (10-60 Hz 0.15mm displacement /60-500 Hz 2g)

**Mounting Position Effects**

Rotation in diaphragm plane has no effect. Tilting up to 90 degree will cause zero shift up to 0.21 kPa (0.84 inH<sub>2</sub>O) which can be corrected by the zero adjustment.

**Response Time (All capsules) “◇”**

90 ms

When software damping is set to zero and including dead time of 45 ms (nominal)

**□ FUNCTIONAL SPECIFICATIONS****Output****For 4 to 20 mA HART / BRAIN (Output signal code D and J)**

Two wire 4 to 20 mA DC output with digital communications, linear or square root programmable. BRAIN or HART FSK protocol are superimposed on the 4 to 20 mA signal.

Output range: 3.6 mA to 21.6 mA  
 Output limits conforming to NAMUR NE43 can be pre-set by option code C2 or C3.

**For 1 to 5 V HART (Output signal code Q)**

Three or four wire low power 1 to 5 V DC output with HART, linear or square root programmable. HART protocol are superimposed on the 1 to 5 V DC signal.

Output range: 0.9 V to 5.4 V DC

**Failure Alarm (Output signal code D and J)****For 4 to 20 mA HART / BRAIN (Output signal code D and J)**

Output status at CPU failure and hardware error;  
 Up-scale: 110%, 21.6 mA DC or more (standard)  
 Down-scale: -5%, 3.2 mA DC or less

**For 1 to 5 V HART (Output signal code Q)**

Analog output status at CPU failure and hardware error;  
 Up-scale: 110%, 5.4 V DC or more (standard)  
 Down-scale: -5%, 0.8 V DC or less

**Damping Time Constant (1st order)**

Amplifier's damping time constant is adjustable from 0.00 to 100.00 s by software and added to response time.

Note: For BRAIN protocol type, when the software damping is set to less than 0.5 s, communication may occasionally be unavailable during the operation, especially while output changes dynamically. The default setting of damping ensures stable communication.

**Update Period “◇”**

Pressure: 45 ms

**Zero Adjustment Limits**

Zero can be fully elevated or suppressed, within the lower and upper range limits of the capsule.

**External Zero Adjustment**

External zero is continuously adjustable with 0.01% incremental resolution of span. Re-range can be done locally using the digital indicator with rangesetting switch.

**Integral Indicator (LCD display, optional) “◇”**

5-digit numerical display, 6-digit unit display and bar graph.

The indicator is configurable to display one or up to three of the following variables periodically; pressure in %, scaled pressure, measured pressure.

See also “Factory Settings.”

**Local Parameter Setting****(Output signal code D, J and Q)**

Parameter configuration by the external zero adjustment screw and push button (Integral indicator code E) offers easy and quick setup for parameters of Loop test, Tag number, Unit, LRV, URV, Damping, Output mode (linear/square root), Display out 1, and Re-range by applying actual pressure (LRV/URV) and Device Information.

**Burst Pressure Limits**

A, B and C capsule: 30 MPa  
 D capsule: 132 MPa

**Self Diagnostics**

CPU failure, hardware failure, configuration error, process alarm for pressure or capsule temperature. User-configurable process high/low alarm for pressure is also available

**Signal Characterizer (Output signal code D, J and Q)**

User-configurable 10-segment signal characterizer for 4 to 20 mA output.

**SIL Certification**

EJA-E series transmitters except Fieldbus, PROFIBUS PA and 1-5V DC with HART(Low Power) communication types are certified in compliance with the following standards;

IEC 61508: 2010;

Functional Safety of Electrical/electronic/programmable electronic related systems; SIL 2 capability for single transmitter use, SIL 3 capability for dual transmitter use.

Reliability Data different depending on hardware and software revision.

For details, refer to Functional Safety Data Sheet.

(Document number: TI 01C25A05-01EN or TI 01C25A05-21EN for option code SLT )

The document can be downloaded from the website of Yokogawa.

(Website address: <https://www.yokogawa.com/solutions/products-platforms/field-instruments/>)

□ **NORMAL OPERATING CONDITION**  
(Optional features or approval codes may affect limits.)

**Ambient Temperature Limits**

- 40 to 85°C (-40 to 185°F)
- 30 to 80°C (-22 to 176°F) with LCD display

**Process Temperature Limits**

- 40 to 120°C (-40 to 248°F)

**Ambient Humidity Limits**

- 0 to 100% RH

**Maximum Over Pressure**

Capsule	Pressure	
	EJA510E	EJA530E
A and B	4 MPa abs (580 psia)	4 MPa (580 psig)
C	20 MPa abs (2900 psia)	20 MPa (2900 psig)
D	60 MPa abs (8700 psia) *	60 MPa (8700 psig) *

\*: 105 MPa (15200 psi) when /HG is specified.

**Working Pressure Limits (Silicone oil)**

**Maximum Pressure Limits**

Capsule	Pressure	
	EJA510E	EJA530E
A	200 kPa abs (29 psia)	200 kPa (29 psig)
B	2 MPa abs (290 psia)	2 MPa (290 psig)
C	10 MPa abs (1450 psia)	10 MPa (1450 psig)
D	50 MPa abs (7200 psia) *	50 MPa (7200 psig) *

\*: 70 MPa (10150 psi) when /HG is specified.

**Minimum Pressure Limit**

See graph below

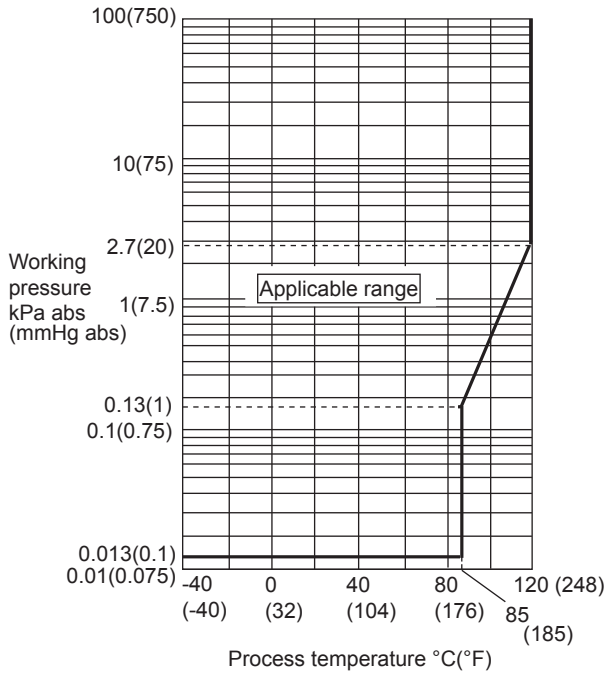

**Figure 1-1. Working Pressure and Process Temperature [For EJA510E]**

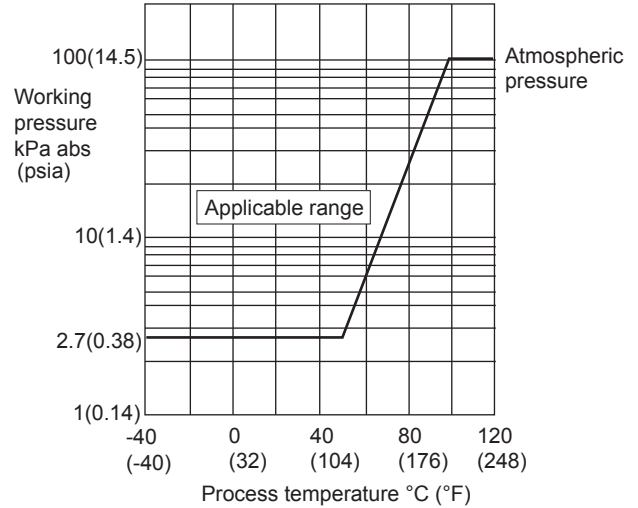

F02E.ai

**Figure 1-2. Working Pressure and Process Temperature [For EJA530E]**

**Supply & Load Requirements**

(Output signal code D and J. Optional features or approval codes may affect electrical requirements.)

With 24 V DC supply, up to a 550Ω load can be used. See graph below.

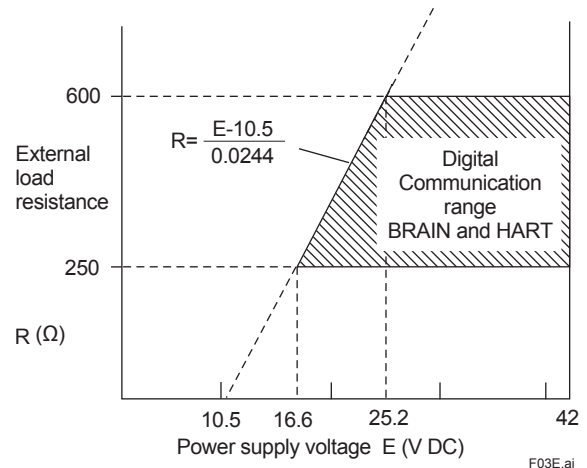

F03E.ai

**Figure 2. Relationship Between Power Supply Voltage and External Load Resistance (Output signal code D and J)**

**Supply Voltage “◇”**

**For 4 to 20 mA HART / BRAIN (Output signal code D and J)**

- 10.5 to 42 V DC for general use and flameproof type.
- 10.5 to 32 V DC for lightning protector (option code A).
- 10.5 to 30 V DC for intrinsically safe, type n, non-incendive or non-sparking type.
- Minimum voltage limited at 16.6 V DC for digital communications, BRAIN and HART

**For 1 to 5 V HART  
(Output signal code Q)**

Power supply :  
9 to 28 V DC for general use and flame proof type.  
Power Consumption :  
0.96 mA to 3 mA, 27 mW

**Load for 4 to 20 mA HART / BRAIN  
(Output signal code D and J)**

0 to 1290Ω for operation  
250 to 600Ω for digital communication

**Output Load for 1 to 5 V HART  
(Output signal code Q)**

1 MΩ or greater (meter input impedance)  
Note that with three-wire connection, the cable length may affect the measurement accuracy of the output signal.

**Communication Requirements “◇”  
(Approval codes may affect electrical requirements.)****BRAIN**

**Communication distance**  
Up to 2 km (1.25 miles) when using CEV polyethylene-insulated PVC-sheathed cables. Communication distance varies depending on type of cable used.

**Load capacitance**  
0.22 μF or less

**Load inductance**  
3.3 mH or less

**Input impedance of communicating device**  
10 kΩ or more at 2.4 kHz.

**EMC Conformity Standards**

EN 61326-1 Class A, Table2  
EN 61326-2-3  
EN 61326-2-5 (for fieldbus)

**European Pressure Equipment Directive  
2014/68/EU**

Sound Engineering Practice (for all capsules)

With option code /PE3 (for D capsule)

Category III, Module H, Type of Equipment: Pressure Accessory-Vessel, Type of Fluid: Liquid and Gas, Group of Fluid: 1 and 2

**EU RoHS Directive**

EN IEC 63000

**Safety Requirement Standards**

EN 61010-1, C22.2 No.61010-1

- Installation category: I  
(Anticipated transient overvoltage 330 V)
- Pollution degree: 2
- Indoor/Outdoor use

**□ PHYSICAL SPECIFICATIONS****Wetted Parts Materials**

**Diaphragm, process connector**  
Refer to “MODEL AND SUFFIX CODES.”

**Non-wetted Parts Materials****Housing**

- Low copper cast aluminum alloy
- Low copper cast aluminum alloy with corrosion resistance properties (copper content ≤ 0.03%, iron content ≤ 0.15%) (optional)
- ASTM CF-8M Stainless steel (optional)

**Coating of housing**

[for aluminum housing]  
Polyester resin powder coating  
Mint-green paint (Munsell 5.6BG 3.3/2.9 or its equivalent)  
[for option code /P□ or /X2]  
Epoxy and polyurethane resin solvent coating

**Degrees of protection**

IP66/IP67, Type 4X

**Pipe**

Polypropylene

**Cover O-rings**

Buna-N, fluoro-rubber (optional)

**Name plate and tag**

316 SST

**Fill fluid**

Silicone, Fluorinated oil (optional)

**Weight**

Capsule A, B and C: 1.2 kg (2.6 lb)\*  
Capsule D: 1.4 kg (3.1 lb)\*  
\*: Without integral indicator and mounting bracket.  
Add 1.5 kg (3.3 lb) for Amplifier housing code 2.

**Connections**

Refer to “MODEL AND SUFFIX CODES.”

**< Related Instruments >**

FieldMate Versatile Device Management Wizard:  
Refer to GS 01R01A01-01E.  
BRAIN TERMINAL: Refer to GS 01C00A11-00E  
Power Distributor: Refer to GS 01B04T01-02E or GS 01B04T02-02E

**< Reference >**

- **DPHarp EIA™**; Registered trademark of Yokogawa Electric Corporation.
  - FieldMate; Registered trademark of Yokogawa Electric Corporation.
  - Hastelloy; Trademark of Haynes International Inc.
  - HART®; Registered trademark of FieldComm Group.
  - FOUNDATION Fieldbus; Trademark of FieldComm Group.
  - PROFIBUS; Registered trademark of Profibus Nutzerorganisation e.v., Karlsruhe, Germany.
- Other company names and product names used in this material are registered trademarks or trademarks of their respective owners.

**MODEL AND SUFFIX CODES**

Model	Suffix Codes	Description
EJA510E EJA530E	..... .....	Absolute pressure transmitter Gauge pressure transmitter
Output signal	-D ..... -J ..... -F ..... -G ..... -Q .....	4 to 20 mA DC Output with digital communication (BRAIN protocol) 4 to 20 mA DC Output with digital communication (HART 5/HART 7 protocol)*1 Digital communication (FOUNDATION Fieldbus protocol, refer to GS 01C31T02-01EN) Digital communication (PROFIBUS PA protocol, refer to GS 01C31T04-01EN) Low Power, 1 to 5 V DC with digital communication (HART 7 protocol)
Measurement span (capsule)	A ..... B ..... C ..... D .....	10 to 200 kPa (1.45 to 29 psi) 0.02 to 2 MPa (2.9 to 290 psi) 0.1 to 10 MPa (14.5 to 1450 psi) 0.5 to 50 MPa (72.5 to 7200 psi)*10
Wetted parts material *2	S ..... H .....	Process connector      Diaphragm      Others 316L SST *11#      Hastelloy C-276 *3#      316L SST # or F316L SST# Hastelloy C-276 *3#      Hastelloy C-276 *3#      Hastelloy C-276 *3#
Process connections * For a diaphragm seal system, refer to process connections code table (p.6).	4 ..... 7 ..... 8 ..... 9 .....	1/2 NPT female 1/2 NPT male G1/2 DIN 16 288 male *4 M20×1.5 DIN 16 288 male *4
—	N .....	Always N
—	-0 .....	Always 0
Amplifier housing	▶ 1 ..... 3 ..... 2 .....	Cast aluminum alloy Cast aluminum alloy with corrosion resistance properties *5 ASTM CF-8M stainless steel *6
Electrical connection	▶ 0 ..... 2 ..... 4 ..... 5 ..... 7 ..... 9 ..... A ..... C ..... D .....	G1/2 female, one electrical connection without blind plugs 1/2 NPT female, two electrical connections without blind plugs M20 female, two electrical connections without blind plugs G1/2 female, two electrical connections with a blind plug*7 1/2 NPT female, two electrical connections with a blind plug*7 M20 female, two electrical connections with a blind plug*7 G1/2 female, two electrical connections and a 316 SST blind plug 1/2 NPT female, two electrical connections and a 316 SST blind plug M20 female, two electrical connections and a 316 SST blind plug
Integral indicator	▶ D ..... E ..... N .....	Digital indicator *8 Digital indicator with the range setting switch (push button) *9 (None)
Mounting bracket	▶ L ..... N .....	316 SST 2-inch pipe mounting None
Optional Codes		□/ Optional specification

The “▶” marks indicates the most typical selection for each specification. Example: EJA530E-DAS4N-012NN/□.

\*1: HART 5 or HART 7 is selectable. Specify upon ordering.

\*2: ⚠ Users must consider the characteristics of selected wetted parts material and the influence of process fluids. The use of inappropriate materials can result in the leakage of corrosive process fluids and cause injury to personnel and/or damage to plant facilities. It is also possible that the diaphragm itself can be damaged and that material from the broken diaphragm and the fill fluid can contaminate the user’s process fluids.

Be very careful with highly corrosive process fluids such as hydrochloric acid, sulfuric acid, hydrogen sulfide, sodium hypochlorite, and high-temperature steam (150°C [302°F] or above). Contact Yokogawa for detailed information of the wetted parts material.

\*3: Hastelloy C-276 or ASTM N10276.

\*4: Not applicable for combination of capsule code D and wetted parts material code H. Threads are based on the withdrawn DIN 16 288.

\*5: Not applicable for electrical connection code 0, 5, 7, 9 and A.

\*6: Not applicable for electrical connection code 0, 5, 7 or 9.

\*7: Material of a blind plug; aluminum alloy for code 5 and 9, and SUS304 for code 7.

\*8: Not applicable for output signal code G.

\*9: Not applicable for output signal code F.

\*10: 5 to 70 MPa (720 to 10150 psi) when /HG is specified.

\*11: Intergranular corrosion test passed according to ASTM A262 Practice E.

The ‘#’ marks indicate the construction materials conform to NACE material recommendations per MR0175/ISO 15156. Please refer to the latest standards for details. Selected materials also conform to NACE MR0103.

**[Process Connections Code for Diaphragm Seal System]**

Following table shows the code dedicated for EJAC50E Diaphragm Seal System. The code cannot be specified without a diaphragm seal system. Please also refer to the GS 01C25W01-01EN for EJAC50E.

Process Connections Code	Description
P	Direct Mount Diaphragm seal system

**■ OPTIONAL SPECIFICATIONS (For Explosion Protected type) “◇”**

For other agency approvals and marine approvals, please refer to GS 01C25A20-01EN.

Please select appropriate equipment in accordance with the laws and regulations of the relevant country/region, when it is used in a location where explosive atmospheres may be present.

Item	Description	Code
Factory Mutual (FM)	FM Explosionproof Approval **1 Applicable Standard: FM3600, FM3615, FM3810, NEMA 250, ANSI/UL 61010-1, ANSI/UL 61010-2-30 Explosionproof for Class I, Division 1, Groups B, C and D, Dust-ignitionproof for Class II/III, Division 1, Groups E, F and G, in Hazardous locations, indoors and outdoors (Enclosure: Type 4X) “FACTORY SEALED, CONDUIT SEAL NOT REQUIRED.” Temperature class: T6, Amb. Temp.: -40 to 60°C (-40 to 140°F)	FF1
	FM Intrinsically safe Approval **1*3 Applicable Standard: FM 3600, FM 3610, FM 3611, FM 3810, ANSI/ISA-60079-0, ANSI/ISA-60079-11, ANSI/ISA-61010-1, NEMA 250 Intrinsically Safe for Class I, Division 1, Groups A, B, C & D, Class II, Division 1, Groups E, F & G and Class III, Division 1, Class I, Zone 0, in Hazardous Locations, AEx ia IIC Nonincendive for Class I, Division 2, Groups A, B, C & D, Class II, Division 2, Groups F & G, Class I, Zone 2, Group IIC, in Hazardous Locations Enclosure: Type 4X, Temp. Class: T4, Amb. Temp.: -60 to 60°C (-75 to 140°F) Intrinsically Safe Apparatus Parameters [Groups A, B, C, D, E, F and G] Vmax=30 V, Imax=200 mA, Pmax=1 W, Ci=6 nF, Li=0 μH [Groups C, D, E, F and G] Vmax=30 V, Imax=225 mA, Pmax=1 W, Ci=6 nF, Li=0 μH	FS1
	Combined FF1 and FS1 **1*3	FU1
ATEX	ATEX Flameproof Approval **1 Applicable Standard: EN IEC 60079-0, EN 60079-1, EN 60079-31 Certificate: KEMA 07ATEX0109 X II 2 G Ex db IIC T6...T4 Gb, II 2 D Ex tb IIIC T85°C Db Degree of protection: IP66/IP67 Amb. Temp. (Tamb) for gas-proof : T4; -50 to 75°C (-58 to 167°F), T5; -50 to 80°C (-58 to 176°F), T6; -50 to 75°C (-58 to 167°F) Process Temp. for gas-proof (Tp): T4; -50 to 120°C (-58 to 248°F), T5; -50 to 100°C (-58 to 212°F), T6; -50 to 85°C (-58 to 185°F) Max. surface Temp. for dust-proof: T85°C (Tamb: -30 to 75°C, Tp: -30 to 85°C) *2	KF22
	ATEX Intrinsically safe Approval **1*3 Applicable Standard: EN IEC 60079-0, EN 60079-11 Certificate: DEKRA 11ATEX0228 X II 1 G Ex ia IIC T4 Ga, II 2 D Ex ia IIIC T85°C T100°C T120°C Db Degree of protection: IP66/IP67 Amb. Temp. (Tamb) for EPL Ga: -50 to 60°C (-58 to 140°F) Maximum Process Temp. (Tp) for EPL Ga: 120°C Electrical data: Ui=30 V, Ii=200 mA, Pi=0.9 W, Ci=27.6 nF, Li=0 μH Amb. Temp. for EPL Db: -30 to 60°C *2 Max. surface Temp. for EPL Db: T85°C (Tp: 80°C), T100°C (Tp: 100°C), T120°C (Tp: 120°C)	KS21
	Multiple types of protection (KF22, KS21 or Intrinsically safe Ex ic) **1*3 Applicable Standard: EN IEC 60079-0, EN 60079-11 II 3 G Ex ic IIC T4 Gc, Amb. Temp.: -30 to 60°C (-22 to 140°F) *2 Ui=30 V, Ci=27.6 nF, Li=0 μH	KU22

Item	Description	Code
<p>Canadian Standards Association (CSA)</p>	<p>CSA Explosionproof Approval *1                      Certificate: 2014354                      Applicable Standard: C22.2 No. 25, C22.2 No. 30, C22.2 No. 94.2, C22.2 No.213                      CAN/CSA-C22.2 No. 61010-1, CAN/CSA-C22.2 No. 61010-2-030, CAN/CSA-C22.2 No. 60079-0                      CAN/CSA-C22.2 No. 60079-1, CAN/CSA-C22.2 No. 60529, ANSI/UL 122701                      [For Explosion-proof]                      Class I, Groups B, C and D.                      Temperature Code: T6...T4                      Process Temp.: T4; -50 to 120°C (-58 to 248°F), T5; -50 to 100°C (-58 to 212°F), T6; -50 to 85°C (-58 to 185°F)                      Amb.Temp.: T4; -50 to 75°C (-58 to 167°F), T5; -50 to 80°C (-58 to 176°F), T6; -50 to 75°C (-58 to 167°F)                      Enclosure: Type 4X                      [For Flameproof]                      Ex d IIC T6...T4                      Process Temp.: T4; -50 to 120°C (-58 to 248°F), T5; -50 to 100°C (-58 to 212°F), T6; -50 to 85°C (-58 to 185°F)                      Amb.Temp.: T4; -50 to 75°C (-58 to 167°F), T5; -50 to 80°C (-58 to 176°F), T6; -50 to 75°C (-58 to 167°F)                      Enclosure: IP66/IP67                      [For Dustignition-proof]                      Class II/III, Groups E, F and G.                      Temp. Code: T85°C                      T85°C (Tamb: -30* to 75°C, Tp: -30* to 85°C) *-15 °C (When fluorinated rubber O-ring is specified)                      Enclosure: Type 4X                      Process seal:                      Dual Seal with Annunciation                      No additional sealing required                      Primary seal failure annunciation: at the zero-adjustment screw.</p>	<p><b>CF1</b></p>
	<p>CSA Intrinsically safe Approval **3                      Certificate: 1606623                      [For Division System]                      Applicable Standard: CAN/CSA C22.2 No.0, CSA C22.2 No.94.2, CSA C22.2 No.213,                      CAN/CSA C22.2 No.61010-1, CAN/CSA C22.2 No.61010-2-030                      Intrinsically Safe for Class I, Division 1, Groups A, B, C &amp; D, Class II, Division 1, Groups E, F &amp; G,                      Class III, Division 1, Nonincendive for Class I, Division 2, Groups A, B, C &amp; D, Class II, Division 2,                      Groups F &amp; G, Class III, Division 1                      Enclosure: Type 4X, Temp. Code: T4 Amb. Temp.: -50 to 60°C(-58 to 140°F) *2                      Electrical Parameters: [Intrinsically Safe] Vmax=30V, Imax=200mA, Pmax=0.9W, Ci=10nF, Li=0 μH                      [Nonincendive] Vmax=30V, Ci=10nF, Li=0 μH                      [For Zone System]                      Applicable Standard: CAN/CSA C22.2 No.60079-0, CAN/CSA C22.2 No.60079-11,                      CAN/CSA E60079-15, CAN/CSA C22.2 No.60529                      Ex ia IIC T4, Ex nL IIC T4 Enclosure: IP66/IP67                      Amb. Temp.: -50 to 60°C(-58 to 140°F) *2, Max. Process Temp.: 120°C(248°F)                      Electrical Parameters: [Ex ia] Ui=30V, Ii=200mA, Pi=0.9W, Ci=10nF, Li=0 μH                      [Ex nL] Ui=30V, Ci=10nF, Li=0 μH                      Process Sealing Certification                      Dual Seal Certified by CSA to the requirement of ANSI/ISA-12.27.01                      No additional sealing required                      Primary seal failure annunciation: at the zero adjustment screw</p>	<p><b>CS1</b></p>
	<p>Combined CF1 and CS1 **3</p>	<p><b>CU1</b></p>

Item	Description	Code
IECEX	IECEx Flameproof Approval *1 Applicable Standard: IEC 60079-0, IEC 60079-1, IEC 60079-31 Certificate: IECEX DEK 14.0046X Enclosure: IP66/IP67 Ex db IIC T6...T4 Gb, Ex tb IIIC T85°C Db Amb. Temp. (Tamb) for gas-proof : T4; -50 to 75°C (-58 to 167°F), T5; -50 to 80°C (-58 to 176°F), T6; -50 to 75°C (-58 to 167°F) Process Temp. for gas-proof (Tp): T4; -50 to 120°C (-58 to 248°F), T5; -50 to 100°C (-58 to 212°F), T6; -50 to 85°C (-58 to 185°F) Max. surface Temp. for dust-proof: T85°C (Tamb: -30 to 75°C, Tp: -30 to 85°C) *2	SF22
	IECEx Intrinsically safe and SF22 *1*3 Intrinsically safe Ex ia Certificate: IECEX DEK 11.0081X Applicable Standard: IEC 60079-0, IEC 60079-11 Ex ia IIC T4 Ga Enclosure: IP66/IP67 Amb. Temp.: -50 to 60°C (-58 to 140°F), Max. Process Temp.: 120°C (248°F) Electrical Parameters: Ui=30V, Ii=200mA, Pi=0.9W, Ci=27.6nF, Li=0 μH Intrinsically safe Ex ic Certificate: IECEX DEK 13.0061X Applicable Standard: IEC 60079-0, IEC 60079-11 Ex ic IIC T4 Gc IP code: IP66 Amb. Temp.: -30 to 60°C (-22 to 140°F) *2, Max. Process Temp.: 120°C (248°F) Electrical Parameters: Ui=30V, Ci=27.6 nF, Li=0 μH Flameproof Refer to SF22	SU22

- \*1: Applicable for Electrical connection code 2, 4, 7, 9, C and D.
- \*2: Lower limit of temperature is -15°C (5°F) when /HE is specified.
- \*3: Not applicable for output signal code Q.

**OPTIONAL SPECIFICATIONS**

Item		Description	Code		
High accuracy type <sup>*16*23</sup>		High accuracy	<b>HAC</b>		
Painting	Color change	Amplifier cover only <sup>*2</sup>	<b>P□</b>		
		Amplifier cover and terminal cover, Munsell 7.5 R4/14	<b>PR</b>		
	Coating change	Anti-corrosion coating <sup>*1</sup>	<b>X2</b>		
316 SST exterior parts		316 SST zero-adjustment screw and setscrews <sup>*14</sup>	<b>HC</b>		
Fluoro-rubber O-ring		All O-rings of amplifier housing. Lower limit of ambient temperature: -15°C (5°F)	<b>HE</b>		
Lightning protector		Transmitter power supply voltage: 10.5 to 32 V DC ( 10.5 to 30 V DC for intrinsically safe type, 9 to 32 V DC for Fieldbus communication type.) Allowable current: Max. 6000 A ( 1×40 μs ), Repeating 1000 A ( 1×40 μs ) 100 times Applicable Standards: IEC 61000-4-4, IEC 61000-4-5	<b>A</b>		
Oil-prohibited use <sup>*23</sup>		Degrease cleansing treatment	<b>K1</b>		
		Degrease cleansing treatment and fluorinated oilfilled capsule. Operating temperature -20 to 80°C (-4 to 176°F)		<b>K2</b>	
		Degrease cleansing treatment	With certificates	<b>K41</b>	
		Degrease cleansing treatment and fluorinated oilfilled capsule. Operating temperature -20 to 80°C (-4 to 176°F)		<b>K42</b>	
Oil-prohibited use with dehydrating treatment <sup>*23</sup>		Degrease cleansing and dehydrating treatment	<b>K5</b>		
		Degrease cleansing and dehydrating treatment with fluorinated oilfilled capsule. Operating temperature -20 to 80°C (-4 to 176°F)		<b>K6</b>	
		Degrease cleansing and dehydrating treatment	With certificates	<b>K45</b>	
		Degrease cleansing and dehydrating treatment with fluorinated oilfilled capsule. Operating temperature -20 to 80°C (-4 to 176°F)		<b>K46</b>	
Capsule fill fluid <sup>*23</sup>		Flourinated oil filled in capsule Operating temperature -20 to 80°C (-4 to 176°F)	<b>K3</b>		
Calibration units <sup>*3</sup>		P calibration (psi unit)	(See Table for Span and Range Limits.)	<b>D1</b>	
		bar calibration (bar unit)		<b>D3</b>	
		M calibration (kgf/cm <sup>2</sup> unit)		<b>D4</b>	
Output limits and failure operation <sup>*4</sup>		Failure alarm down-scale : Output status at CPU failure and hardware error is -5%, 3.2mA DC or less for 4 to 20 mA output type and -5%, 0.8V DC or less for 1 to 5 V output type.		<b>C1</b>	
		NAMUR NE43 Compliant Output signal limits: 3.8 mA to 20.5 mA <sup>*17</sup>	Failure alarm down-scale: Output status at CPU failure and hardware error is -5%, 3.2 mA DC or less.		<b>C2</b>
			Failure alarm up-scale: Output status at CPU failure and hardware error is 110%, 21.6 mA or more.		<b>C3</b>
Gold-plated diaphragm <sup>*13*23</sup>		Surface of isolating diaphragms are gold plated, effective for hydrogen permeation.		<b>A1</b>	
Wired tag plate		316 SST tag plate wired onto transmitter		<b>N4</b>	
Data configuration at factory <sup>*5</sup>		Data configuration for HART communication type	Software damping, Descriptor, Message	<b>CA</b>	
		Data configuration for BRAIN communication type	Software damping	<b>CB</b>	
		Data configuration for HART communication type	Software damping, Descriptor, Message, External zero adjustment prohibition setting	<b>CJ</b>	
		Data configuration for BRAIN communication type	Software damping, External zero adjustment prohibition setting	<b>CK</b>	
European Pressure Equipment Directive <sup>*15*16*23</sup>		PED 2014/68/EU Category: III, Module: H, Type of Equipment: Pressure Accessory-Vessel, Type of Fluid: Liquid and Gas, Group of Fluid: 1 and 2		<b>PE3</b>	
Material certificate <sup>*6*23</sup>		Process Connector		<b>M15</b>	
		Process connector, Diaphragm, Capsule body		<b>MA2</b>	
Calibration certificate		Text, Traceability		<b>L4</b>	
		Text, Traceability, Primary standards list		<b>L5</b>	
		Text, Traceability, Primary standards list, Calibration equipment list		<b>L6</b>	
		Text, Traceability, Primary standards list, Calibration equipment list, Calibration equipment certificate		<b>L9</b>	
Pressure test/ Leak test certificate <sup>*12*23</sup>		Test Pressure: 200 kPa (29 psi) <sup>*7</sup>	Nitrogen Gas or Water <sup>*11</sup> Retention time: one minute	<b>T05</b>	
		Test Pressure: 2 MPa (290 psi) <sup>*8</sup>		<b>T06</b>	
		Test Pressure: 10 MPa (1450 psi) <sup>*9</sup>		<b>T07</b>	
		Test Pressure: 50 MPa (7200 psi) <sup>*10</sup>		<b>T08</b>	
		Test Pressure: 70 MPa (10150 psi) <sup>*19</sup>		<b>T15</b>	

Item	Description	Code
High Pressure-proof structure*18*23	Maximum pressure limit and maximum span : 70 MPa.	HG
Parameter list*20	List of setting and adjustment parameters	YP
Additional blind plug*24	Additional blind plug is attached to the conduit connection on both sides for storing transmitter	PP

- \*1: Not applicable with color change option.
- \*2: Not applicable for amplifier housing code 2 and 3.
- \*3: The unit of MWP (Max. working pressure) on the name plate of a housing is the same unit as specified by option codes D1, D3, and D4.
- \*4: Applicable for output signal codes D and J. The hardware error indicates faulty amplifier or capsule.
- \*5: Also see 'Ordering Information'.
- \*6: Material traceability certification, per EN 10204 3.1 B.
- \*7: Applicable for capsule code A.
- \*8: Applicable for capsule code B.
- \*9: Applicable for capsule code C.
- \*10: Applicable for capsule code D without /HG.
- \*11: Dry nitrogen gas or pure water is used for oil-prohibited use (option codes K1, K2, K5, K6, K41, K42, K45, and K46).
- \*12: The unit on the certificate is always kPa/MPa regardless of selection of option code D1, D3 and D4.
- \*13: Applicable for wetted parts material code S.
- \*14: 316 or 316L SST. The specification is included in amplifier code 2.
- \*15: Applicable for measurement span code D. If compliance with category III is needed, specify this option code.
- \*16: Not applicable for output signal code Q.
- \*17: The 1 to 5 V voltage output corresponding to 4 to 20 mA current output is applied to output signal code Q which is non-compliant to NAMUR NE43.
- \*18: Applicable for capsule code D.
- \*19: Applicable for capsule code D with /HG specified.
- \*20: Applicable for output signal code D and J.
- \*21: (Not used)
- \*22: (Not used)
- \*23: Not applicable with process connections code for diaphragm seal system P.
- \*24: Not applicable for electrical connection codes 0, 2, and 4.

## ■ OPTIONAL SPECIFICATIONS (for Diaphragm Seal System)

Following table shows the option codes dedicated for EJAC50E Diaphragm Seal System. These codes cannot be specified without a diaphragm seal system. Please also refer to the GS 01C25W01-01EN for EJAC50E.

Item	Description	Code
Oil-prohibited use	Degrease cleansing treatment	K11
	Degrease cleansing treatment and fluorinated oilfilled capsule. Operating temperature -20 to 80°C (-4 to 176°F)	K12
Oil-prohibited use with dehydrating treatment	Degrease cleansing and dehydrating treatment	K15
	Degrease cleansing and dehydrating treatment with fluorinated oilfilled capsule. Operating temperature -20 to 80°C (-4 to 176°F)	K16
Capsule fill fluid	Fluorinated oil filled in capsule Operating temperature -20 to 80°C (-4 to 176°F)	K13

**■ DIMENSIONS**

Unit: mm (approx.inch)

**Model EJA510E and EJA530E**

- With process connections code 7

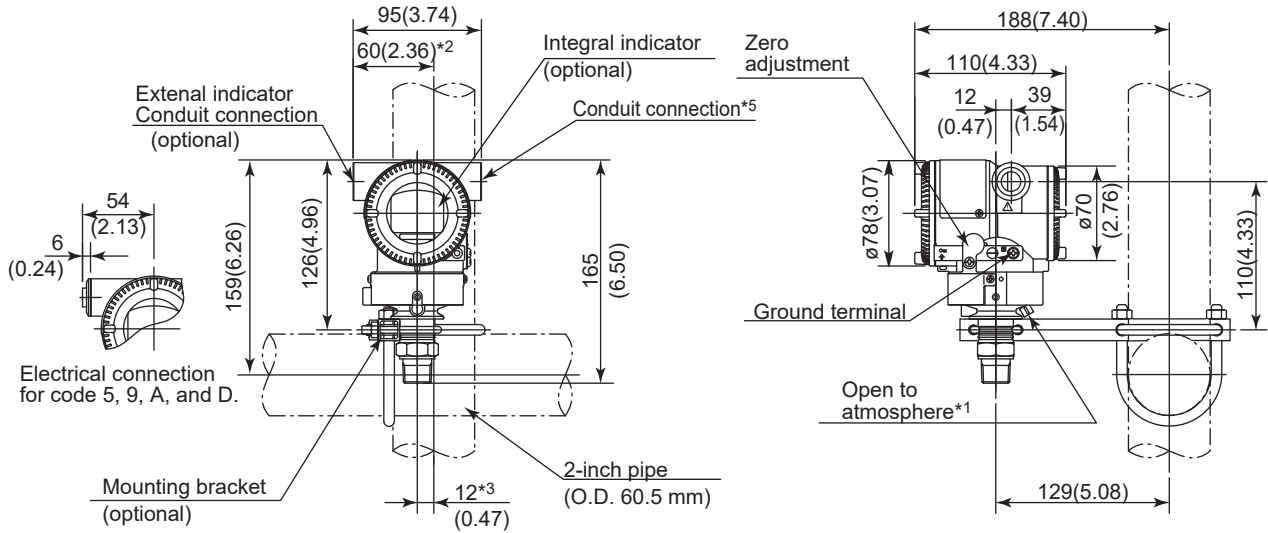

\*1: Only for EJA530E whose measurement span code is A, B, or C.

\*2: 58 mm (2.28 inch) for measurement span code D.

\*3: 11 mm (0.43 inch) for measurement span code D.

\*4: When electrical connection code 7 or C is selected, a blind plug is protruded upto 8 mm (0.31 inch) from the conduit connection.

\*5: When option code PP is selected, a blind plug is attached to the conduit connection on both sides.

- With Process connections code 4

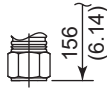

- With Process connections code 8 and 9

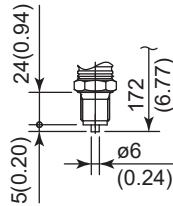

F04E.ai

• Terminal Configuration

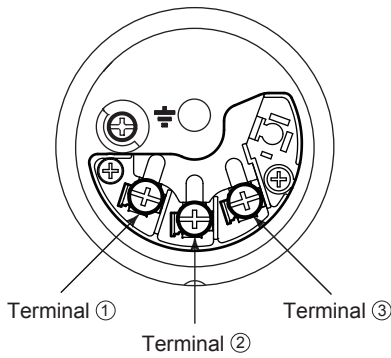

• Terminal Wiring for 4 to 20 mA output, FOUNDATION Fieldbus and PROFIBUS PA communication types

SUPPLY	+	①	] Power supply and output terminals
	-	②	
CHECK	+	③	] External indicator (ammeter) terminals**2
	-	②	
			⏏ Ground terminal

\*1: When using an external indicator or check meter, the internal resistance must be 10 Ω or less.

\*2: Not available for FOUNDATION Fieldbus and PROFIBUS PA communication types.

• Terminal Wiring for 1 to 5 V output

SUPPLY	+	①	] Power supply terminals
	-	②	
VOUT	+	③	] 1 to 5 V DC with HART communication terminals
	-	②	
			⏏ Ground terminal

Three or four wire connection. For four wire connection, both supply and signal lines use SUPPLY - terminal.

F05E.ai

**< Ordering Information > “◇”**

Specify the following when ordering

1. Model, suffix codes, and option codes
2. Calibration range and units
  - 1) Calibration range can be specified with range value specifications up to 5 digits (excluding any decimal point) for low or high range limits within the range of -32000 to 32000. When reverse range is designated, specify Lower Range Value (LRV) as greater than Upper Range Value (URV).
  - 2) Specify only one unit from the table, 'Factory Settings' when shipped.'
3. Display scale and units (for transmitters equipped with integral indicator only)
 

Specify either 0 to 100 % or engineering unit scale and 'Range and Unit' for engineering units scale: Scale range can be specified with range limit specifications up to 5 digits (excluding any decimal point) for low or high range limits within the range of -32000 to 32000. The unit display consists of 6-digit, therefore, if the specified unit is longer than 7 characters excluding '/', the first 6 characters will be displayed on the unit display.
4. HART PROTOCOL
 

When output signal code is "J", specify the HART protocol revision "5" or "7".
5. TAG NO (if required)
 

Specified characters (up to 16 characters for BRAIN, 22 characters for HART, or 16 characters for /N4 tag) are engraved on the stainless steel tag plate fixed on the housing.
6. SOFTWARE TAG (for HART only. if required)
 

Specified characters (up to 32 characters) are set as "Tag" (the first 8 characters) and "Long tag"<sup>\*1</sup> (32 characters) in the amplifier memory. Use alphanumeric capital letters.

When the "SOFTWARE TAG" is not specified, specified "TAG NO" is set as "Tag" (the first 8 characters) and "Long tag"<sup>\*1</sup> (22 characters) in the amplifier memory.

<sup>\*1</sup>: applicable only when HART 7 is selected.
7. Other factory configurations (if required) Specifying option code /CA, /CB, /CJ or /CK will allow further configuration at factory. Following are configurable items and setting range.
 

[/CA, /CJ : For HART communication type]

  - 1) Descriptor (up to 16 characters)
  - 2) Message (up to 30 characters)
  - 3) Software damping in second (0.00 to 100.00)

[/CB, /CK : For BRAIN communication type]

  - 1) Software damping in second (0.00 to 100.00)

**< Factory Setting > “◇”**

Tag number	As specified in order
Software damping <sup>*1</sup>	'2.00 s' or as specified in order
Calibration range lower range value	As specified in order
Calibration range upper range value	As specified in order
Calibration range units	[EJA530E] Selected from mmH <sub>2</sub> O, mmH <sub>2</sub> O(68°F), mmAq <sup>*2</sup> , mmWG <sup>*2</sup> , mmHg, Pa, hPa <sup>*2</sup> , kPa, MPa, mbar, bar, gf/cm <sup>2</sup> , kgf/cm <sup>2</sup> , inH <sub>2</sub> O, inH <sub>2</sub> O(68°F), inHg, ftH <sub>2</sub> O, ftH <sub>2</sub> O(68°F) or psi. (Only one unit can be specified) [EJA510E] Torr, Pa abs, hPa abs <sup>*2</sup> , kPa abs, MPa abs, mbar abs, bar abs, kgf/cm <sup>2</sup> abs, mmH <sub>2</sub> O abs, mmH <sub>2</sub> O abs(68°F), mmHg abs, inH <sub>2</sub> O abs, inH <sub>2</sub> O abs(68°F), inHg abs, ftH <sub>2</sub> O abs, ftH <sub>2</sub> O abs(68°F), psia, atm.
Display setting	Designated value specified in order. (% , or user scaled value.)

<sup>\*1</sup>: To specify these items at factory, /CA, /CB, /CJ or /CK option is required.  
<sup>\*2</sup>: Not available for HART protocol type.

**< Material Cross Reference >**

ASTM	JIS
grade 316	SUS316
grade 316L	SUS316L
grade 304	SUS304

**<Information on EU WEEE Directive>**

EU WEEE (Waste Electrical and Electronic Equipment) Directive is only valid in the EU.

This instrument is intended to be sold and used only as a part of equipment which is excluded from WEEE Directive, such as large-scale stationary industrial tools, a large-scale fixed installation and so on, and, therefore, subjected to the exclusion from the scope of the WEEE Directive. The instrument should be disposed of in accordance with local and national legislation/regulations.